



⚠ Read this manual carefully before operating this vehicle.

OWNER'S MANUAL

XJR1300

XJR1300A

5WM-28199-28

 **Read this manual carefully before operating this vehicle. This manual should stay with this vehicle if it is sold.**

Welcome to the Yamaha world of motorcycling!

As the owner of the XJR1300A, you are benefiting from Yamaha's vast experience and newest technology regarding the design and manufacture of high-quality products, which have earned Yamaha a reputation for dependability.

Please take the time to read this manual thoroughly, so as to enjoy all advantages of your XJR1300A. The Owner's Manual does not only instruct you in how to operate, inspect and maintain your motorcycle, but also in how to safeguard yourself and others from trouble and injury.

In addition, the many tips given in this manual will help keep your motorcycle in the best possible condition. If you have any further questions, do not hesitate to contact your Yamaha dealer.

The Yamaha team wishes you many safe and pleasant rides. So, remember to put safety first!

Yamaha continually seeks advancements in product design and quality. Therefore, while this manual contains the most current product information available at the time of printing, there may be minor discrepancies between your motorcycle and this manual. If there is any question concerning this manual, please consult a Yamaha dealer.





Please read this manual carefully and completely before operating this motorcycle.

IMPORTANT MANUAL INFORMATION

EAU10132

Particularly important information is distinguished in this manual by the following notations:

	This is the safety alert symbol. It is used to alert you to potential personal injury hazards. Obey all safety messages that follow this symbol to avoid possible injury or death.
 WARNING	A WARNING indicates a hazardous situation which, if not avoided, could result in death or serious injury.
NOTICE	A NOTICE indicates special precautions that must be taken to avoid damage to the vehicle or other property.
TIP	A TIP provides key information to make procedures easier or clearer.

IMPORTANT MANUAL INFORMATION

EAU10200

**XJR1300A
OWNER'S MANUAL
©2010 by Yamaha Motor Co., Ltd.
1st edition, August 2010
All rights reserved.
Any reprinting or unauthorized use
without the written permission of
Yamaha Motor Co., Ltd.
is expressly prohibited.
Printed in Japan.**

TABLE OF CONTENTS

LOCATION OF IMPORTANT

LABELS 1-1

SAFETY INFORMATION 2-1

DESCRIPTION 3-1

Left view 3-1

Right view 3-2

Controls and instruments 3-3

INSTRUMENT AND CONTROL

FUNCTIONS 4-1

Immobilizer system 4-1

Main switch/steering lock 4-2

Indicator lights and warning
lights 4-4

Speedometer 4-5

Tachometer 4-5

Multi-function display 4-6

Handlebar switches 4-9

Clutch lever 4-10

Shift pedal 4-11

Brake lever 4-11

Brake pedal 4-12

Fuel tank cap 4-12

Fuel 4-13

Fuel tank breather/overflow
hose 4-14

Catalytic converters 4-14

Seat 4-15

Helmet holder 4-16

Storage compartment 4-16

Adjusting the front fork 4-17

Adjusting the shock absorber
assembly 4-18

Luggage strap holders 4-21

EXUP system 4-21

Sidestand 4-22

Ignition circuit cut-off system 4-22

FOR YOUR SAFETY –

PRE-OPERATION CHECKS 5-1

OPERATION AND IMPORTANT

RIDING POINTS 6-1

Starting the engine 6-1

Shifting 6-2

Tips for reducing fuel
consumption 6-3

Engine break-in 6-3

Parking 6-4

PERIODIC MAINTENANCE AND

ADJUSTMENT 7-1

Owner's tool kit 7-2

Periodic maintenance chart for
the emission control system 7-3

General maintenance and
lubrication chart 7-4

Removing and installing panels 7-8

Checking the spark plugs 7-9

Engine oil and oil filter element 7-10

Replacing the air filter element
and cleaning the check hose 7-13

Checking the throttle grip free
play 7-14

Valve clearance 7-15

Tires 7-15

Cast wheels 7-17

Clutch lever 7-18

Checking the brake lever free
play 7-18

Brake light switches 7-19

Checking the front and rear brake
pads 7-19

Checking the brake and
clutch fluid levels 7-20

Changing the brake and
clutch fluids 7-21

Drive chain slack 7-22

Cleaning and lubricating
the drive chain 7-23

Checking and lubricating
the cables 7-24

Checking and lubricating
the throttle grip and cable 7-24

Checking and lubricating
the brake and shift pedals 7-24

Checking and lubricating
the brake and clutch levers 7-25

Checking and lubricating the
centerstand and sidestand 7-26

TABLE OF CONTENTS

Lubricating the swingarm pivots	7-26
Checking the front fork	7-27
Checking the steering	7-27
Checking the wheel bearings	7-28
Battery	7-28
Replacing the fuses	7-29
Replacing the headlight bulb	7-30
Tail/brake light	7-32
Replacing a turn signal light bulb	7-32
Replacing the license plate light bulb	7-33
Replacing the auxiliary light bulb	7-33
Front wheel	7-34
Rear wheel	7-35
Troubleshooting	7-37
Troubleshooting chart	7-38

Motorcycle noise regulation (for Australia)	10-2
---	------

MOTORCYCLE CARE AND

STORAGE	8-1
Matte color caution	8-1
Care	8-1
Storage	8-3

SPECIFICATIONS	9-1
-----------------------------	-----

CONSUMER INFORMATION	10-1
Identification numbers	10-1

LOCATION OF IMPORTANT LABELS

EAU10384

1

Read and understand all of the labels on your vehicle. They contain important information for safe and proper operation of your vehicle. Never remove any labels from your vehicle. If a label becomes difficult to read or comes off, a replacement label is available from your Yamaha dealer.

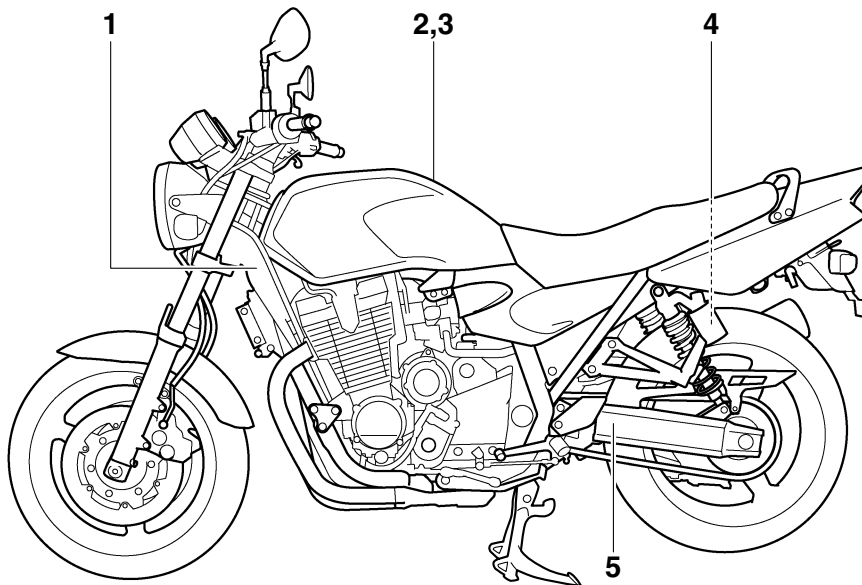

LOCATION OF IMPORTANT LABELS

1

STATIONARY NOISE TEST INFORMATION
TESTED 89 dB(A) AT 4000 r/min
SILENCING SYSTEM : YAMAHA
IDENTIFICATION : 5WVG
5WM-2118G-10

2

⚠ WARNING

- BEFORE YOU OPERATE THIS VEHICLE, READ THE OWNER'S MANUAL AND ALL LABELS.
- ALWAYS WEAR AN APPROVED MOTORCYCLE HELMET, eye protection, and protective clothing.

5GK-2118K-00

3

Use PREMIUM unleaded gasoline with min. 95 octane(ROX).
2S3-2817K-00

5

TIRE INFORMATION

Cold tire normal pressure should be set as follows.

- Up to 90 kg (198 lbs) load

FRONT : 250 kPa, (2.50 kgf/cm²), 36 psi
REAR : 250 kPa, (2.50 kgf/cm²), 36 psi

- 90kg (198 lbs) ~ maximum load

FRONT : 250 kPa, (2.50 kgf/cm²), 36 psi
REAR : 290 kPa, (2.90 kgf/cm²), 42 psi

5JW-21668-00

4



1

SAFETY INFORMATION

EAU10287

2

Be a Responsible Owner

As the vehicle's owner, you are responsible for the safe and proper operation of your motorcycle.

Motorcycles are single-track vehicles. Their safe use and operation are dependent upon the use of proper riding techniques as well as the expertise of the operator. Every operator should know the following requirements before riding this motorcycle.

He or she should:

- Obtain thorough instructions from a competent source on all aspects of motorcycle operation.
- Observe the warnings and maintenance requirements in this Owner's Manual.
- Obtain qualified training in safe and proper riding techniques.
- Obtain professional technical service as indicated in this Owner's Manual and/or when made necessary by mechanical conditions.

Safe Riding

Perform the pre-operation checks each time you use the vehicle to make sure it is in safe operating condition. Failure to inspect or maintain the vehicle properly increases the possibility of an accident or equipment damage. See page 5-1 for a list of pre-operation checks.

- This motorcycle is designed to carry the operator and a passenger.
- The failure of motorists to detect and recognize motorcycles in traffic is the predominating cause of automobile/motorcycle accidents. Many accidents have been caused by an automobile driver who did not see the motorcycle. Making yourself conspicuous appears to be very effective in reducing the chance of this type of accident.

Therefore:

- Wear a brightly colored jacket.
- Use extra caution when you are approaching and passing through intersections, since intersections are the most likely places for motorcycle accidents to occur.

- Ride where other motorists can see you. Avoid riding in another motorist's blind spot.
- Many accidents involve inexperienced operators. In fact, many operators who have been involved in accidents do not even have a current motorcycle license.
- Make sure that you are qualified and that you only lend your motorcycle to other qualified operators.
- Know your skills and limits. Staying within your limits may help you to avoid an accident.
- We recommend that you practice riding your motorcycle where there is no traffic until you have become thoroughly familiar with the motorcycle and all of its controls.
- Many accidents have been caused by error of the motorcycle operator. A typical error made by the operator is veering wide on a turn

due to excessive speed or undercornering (insufficient lean angle for the speed).

- Always obey the speed limit and never travel faster than warranted by road and traffic conditions.
- Always signal before turning or changing lanes. Make sure that other motorists can see you.
- The posture of the operator and passenger is important for proper control.
 - The operator should keep both hands on the handlebar and both feet on the operator footrests during operation to maintain control of the motorcycle.
 - The passenger should always hold onto the operator, the seat strap or grab bar, if equipped, with both hands and keep both feet on the passenger footrests. Never carry a passenger unless he or she can firmly place both feet on the passenger footrests.
- Never ride under the influence of alcohol or other drugs.

- This motorcycle is designed for on-road use only. It is not suitable for off-road use.

Protective Apparel

The majority of fatalities from motorcycle accidents are the result of head injuries. The use of a safety helmet is the single most critical factor in the prevention or reduction of head injuries.

- Always wear an approved helmet.
- Wear a face shield or goggles. Wind in your unprotected eyes could contribute to an impairment of vision that could delay seeing a hazard.
- The use of a jacket, heavy boots, trousers, gloves, etc., is effective in preventing or reducing abrasions or lacerations.
- Never wear loose-fitting clothes, otherwise they could catch on the control levers, footrests, or wheels and cause injury or an accident.
- Always wear protective clothing that covers your legs, ankles, and feet. The engine or exhaust system become very hot during or after operation and can cause burns.

- A passenger should also observe the above precautions.

Avoid Carbon Monoxide Poisoning

All engine exhaust contains carbon monoxide, a deadly gas. Breathing carbon monoxide can cause headaches, dizziness, drowsiness, nausea, confusion, and eventually death.

Carbon Monoxide is a colorless, odorless, tasteless gas which may be present even if you do not see or smell any engine exhaust. Deadly levels of carbon monoxide can collect rapidly and you can quickly be overcome and unable to save yourself. Also, deadly levels of carbon monoxide can linger for hours or days in enclosed or poorly ventilated areas. If you experience any symptoms of carbon monoxide poisoning, leave the area immediately, get fresh air, and **SEEK MEDICAL TREATMENT**.

- Do not run engine indoors. Even if you try to ventilate engine exhaust with fans or open windows and doors, carbon monoxide can rapidly reach dangerous levels.

SAFETY INFORMATION

2

- Do not run engine in poorly ventilated or partially enclosed areas such as barns, garages, or carports.
- Do not run engine outdoors where engine exhaust can be drawn into a building through openings such as windows and doors.

Loading

Adding accessories or cargo to your motorcycle can adversely affect stability and handling if the weight distribution of the motorcycle is changed. To avoid the possibility of an accident, use extreme caution when adding cargo or accessories to your motorcycle. Use extra care when riding a motorcycle that has added cargo or accessories. Here, along with the information about accessories below, are some general guidelines to follow if loading cargo to your motorcycle:

The total weight of the operator, passenger, accessories and cargo must not exceed the maximum load limit.

Operation of an overloaded vehicle could cause an accident.

Maximum load:
205 kg (452 lb)

When loading within this weight limit, keep the following in mind:

- Cargo and accessory weight should be kept as low and close to the motorcycle as possible. Securely pack your heaviest items as close to the center of the vehicle as possible and make sure to distribute the weight as evenly as possible on both sides of the motorcycle to minimize imbalance or instability.
- Shifting weights can create a sudden imbalance. Make sure that accessories and cargo are securely attached to the motorcycle before riding. Check accessory mounts and cargo restraints frequently.
 - Properly adjust the suspension for your load (suspension-adjustable models only), and check the condition and pressure of your tires.
 - Never attach any large or heavy items to the handlebar, front fork, or front fender. These

items, including such cargo as sleeping bags, duffel bags, or tents, can create unstable handling or a slow steering response.

- **This vehicle is not designed to pull a trailer or to be attached to a sidecar.**

Genuine Yamaha Accessories

Choosing accessories for your vehicle is an important decision. Genuine Yamaha accessories, which are available only from a Yamaha dealer, have been designed, tested, and approved by Yamaha for use on your vehicle.

Many companies with no connection to Yamaha manufacture parts and accessories or offer other modifications for Yamaha vehicles. Yamaha is not in a position to test the products that these aftermarket companies produce. Therefore, Yamaha can neither endorse nor recommend the use of accessories not sold by Yamaha or modifications not specifically recommended by Yamaha, even if sold and installed by a Yamaha dealer.

Aftermarket Parts, Accessories, and Modifications

While you may find aftermarket products similar in design and quality to genuine Yamaha accessories, recognize that some aftermarket accessories or modifications are not suitable because of potential safety hazards to you or others. Installing aftermarket products or having other modifications performed to your vehicle that change any of the vehicle's design or operation characteristics can put you and others at greater risk of serious injury or death. You are responsible for injuries related to changes in the vehicle.

Keep the following guidelines in mind, as well as those provided under "Loading" when mounting accessories.

- Never install accessories or carry cargo that would impair the performance of your motorcycle. Carefully inspect the accessory before using it to make sure that it does not in any way reduce ground clearance or cornering clearance,

limit suspension travel, steering travel or control operation, or obscure lights or reflectors.

- Accessories fitted to the handlebar or the front fork area can create instability due to improper weight distribution or aerodynamic changes. If accessories are added to the handlebar or front fork area, they must be as lightweight as possible and should be kept to a minimum.
- Bulky or large accessories may seriously affect the stability of the motorcycle due to aerodynamic effects. Wind may attempt to lift the motorcycle, or the motorcycle may become unstable in cross winds. These accessories may also cause instability when passing or being passed by large vehicles.
- Certain accessories can displace the operator from his or her normal riding position. This improper position limits the freedom of movement of the opera-

tor and may limit control ability, therefore, such accessories are not recommended.

- Use caution when adding electrical accessories. If electrical accessories exceed the capacity of the motorcycle's electrical system, an electric failure could result, which could cause a dangerous loss of lights or engine power.

Aftermarket Tires and Rims

The tires and rims that came with your motorcycle were designed to match the performance capabilities and to provide the best combination of handling, braking, and comfort. Other tires, rims, sizes, and combinations may not be appropriate. Refer to page 7-15 for tire specifications and more information on replacing your tires.

Transporting the Motorcycle

Be sure to observe following instructions before transporting the motorcycle in another vehicle.

- Remove all loose items from the motorcycle.

SAFETY INFORMATION

2

- Check that the fuel cock (if equipped) is in the “OFF” position and that there are no fuel leaks.
- Point the front wheel straight ahead on the trailer or in the truck bed, and choke it in a rail to prevent movement.
- Shift the transmission in gear (for models with a manual transmission).
- Secure the motorcycle with tie-downs or suitable straps that are attached to solid parts of the motorcycle, such as the frame or upper front fork triple clamp (and not, for example, to rubber-mounted handlebars or turn signals, or parts that could break). Choose the location for the straps carefully so the straps will not rub against painted surfaces during transport.
- The suspension should be compressed somewhat by the tie-downs, if possible, so that the motorcycle will not bounce excessively during transport.

Left view

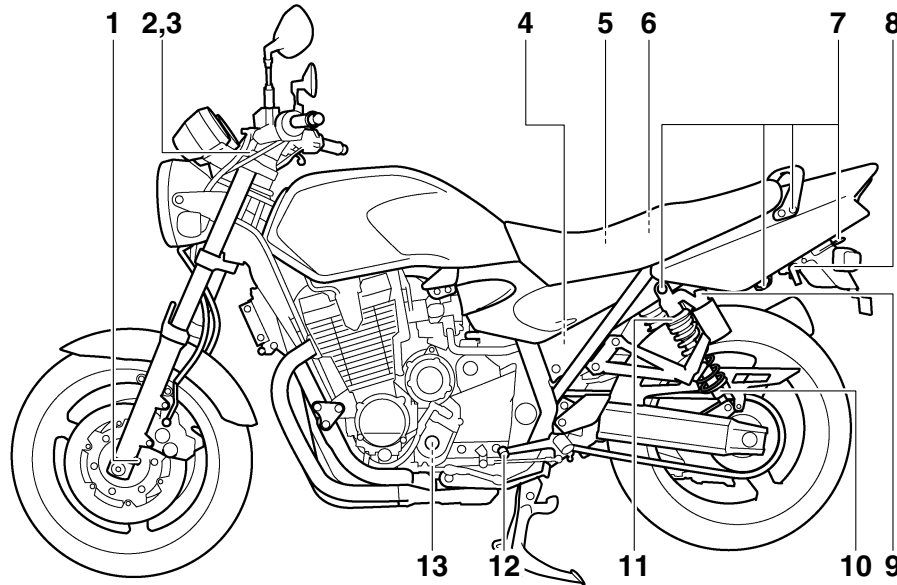

1. Front fork compression damping force adjusting screw (page 4-17)
2. Front fork spring preload adjusting bolt (page 4-17)
3. Front fork rebound damping force adjusting screw (page 4-17)
4. Fuse box (page 7-29)
5. Main fuse (page 7-29)
6. Owner's tool kit (page 7-2)
7. Luggage strap holder (page 4-21)
8. Seat lock/helmet holder (page 4-15/page 4-16)

9. Shock absorber assembly compression damping force adjusting knob (page 4-18)
10. Shock absorber assembly rebound damping force adjusting knob (page 4-18)
11. Shock absorber assembly spring preload adjusting ring (page 4-18)
12. Shift pedal (page 4-11)
13. Engine oil filter element (page 7-10)

DESCRIPTION

EAU10420

Right view

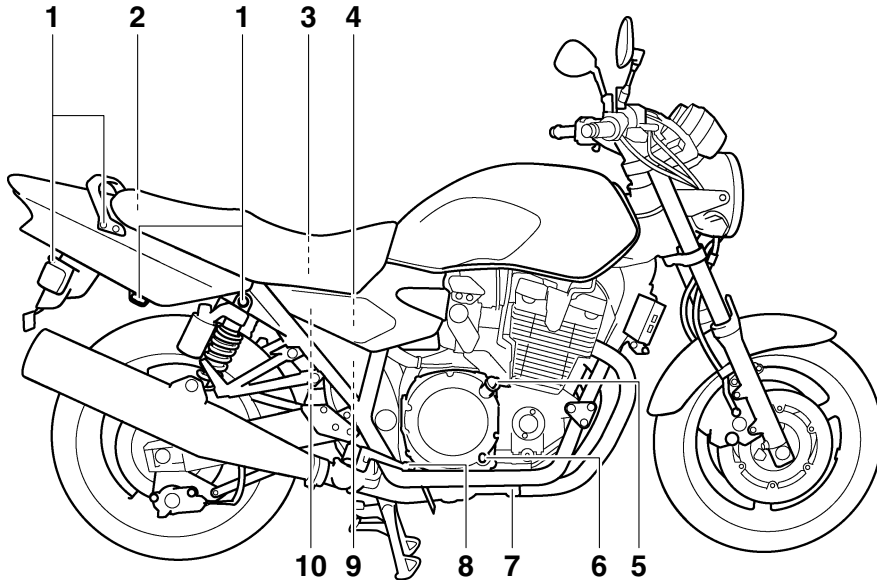

3

- 1. Luggage strap holder (page 4-21)
- 2. Storage compartment (page 4-16)
- 3. Battery (page 7-28)
- 4. Air filter element (page 7-13)
- 5. Engine oil filler cap (page 7-10)
- 6. Engine oil level check window (page 7-10)
- 7. Engine oil drain bolt (page 7-10)
- 8. Brake pedal (page 4-12)
- 9. Rear brake light switch (page 7-19)
- 10. Rear brake fluid reservoir (page 7-20)

Controls and instruments

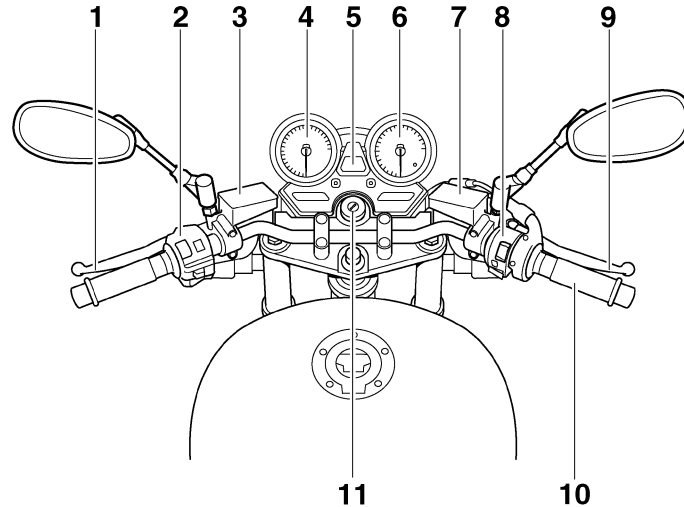

1. Clutch lever (page 4-10)
2. Left handlebar switches (page 4-9)
3. Clutch fluid reservoir (page 7-20)
4. Speedometer (page 4-5)
5. Multi-function display (page 4-6)
6. Tachometer (page 4-5)
7. Front brake fluid reservoir (page 7-20)
8. Right handlebar switches (page 4-9)

9. Brake lever (page 4-11)
10. Throttle grip (page 7-14)
11. Main switch/steering lock (page 4-2)

INSTRUMENT AND CONTROL FUNCTIONS

Immobilizer system

EAU10977

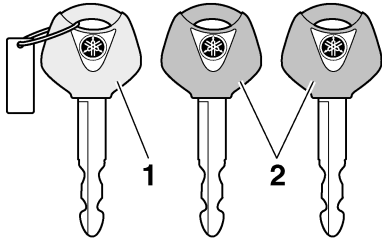

1. Code re-registering key (red bow)
2. Standard keys (black bow)

This vehicle is equipped with an immobilizer system to help prevent theft by re-registering codes in the standard keys. This system consists of the following:

- a code re-registering key (with a red bow)
- two standard keys (with a black bow) that can be re-registered with new codes
- a transponder (which is installed in the code re-registering key)
- an immobilizer unit
- an ECU

- an immobilizer system indicator light (See page 4-5.)

The key with the red bow is used to register codes in each standard key. Since re-registering is a difficult process, take the vehicle along with all three keys to a Yamaha dealer to have them re-registered. Do not use the key with the red bow for driving. It should only be used for re-registering the standard keys. Always use a standard key for driving.

ECA11821

NOTICE

- **DO NOT LOSE THE CODE RE-REGISTERING KEY! CONTACT YOUR DEALER IMMEDIATELY IF IT IS LOST!** If the code re-registering key is lost, registering new codes in the standard keys is impossible. The standard keys can still be used to start the vehicle, however if code re-registering is required (i.e., if a new standard key is made or all keys are lost) the entire immobilizer system must be replaced. Therefore, it is highly recom-

mended to use either standard key and keep the code re-registering key in a safe place.

- Do not submerge any key in water.
- Do not expose any key to excessively high temperatures.
- Do not place any key close to magnets (this includes, but not limited to, products such as speakers, etc.).
- Do not place items that transmit electrical signals close to any key.
- Do not place heavy items on any key.
- Do not grind any key or alter its shape.
- Do not disassemble the plastic part of any key.
- Do not put two keys of any immobilizer system on the same key ring.
- Keep the standard keys as well as keys of other immobilizer systems away from this vehicle's code re-registering key.

INSTRUMENT AND CONTROL FUNCTIONS

- Keep other immobilizer system keys away from the main switch as they may cause signal interference.

Main switch/steering lock

EAU10472

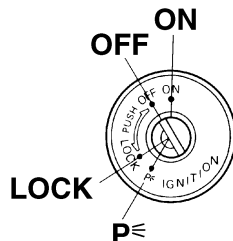

The main switch/steering lock controls the ignition and lighting systems, and is used to lock the steering. The various positions are described below.

TIP

Be sure to use the standard key (black bow) for regular use of the vehicle. To minimize the risk of losing the code re-registering key (red bow), keep it in a safe place and only use it for code re-registering.

EAU43410

ON

All electrical circuits are supplied with power; the meter lighting, taillights, license plate light and auxiliary light come on, and the engine can be started. The key cannot be removed.

TIP

The headlight comes on automatically when the engine is started and stays on until the key is turned to "OFF", even if the engine stalls.

EAU10661

OFF

All electrical systems are off. The key can be removed.

EWA10061

WARNING

Never turn the key to "OFF" or "LOCK" while the vehicle is moving. Otherwise the electrical systems will be switched off, which may result in loss of control or an accident.

INSTRUMENT AND CONTROL FUNCTIONS

EAU10691

LOCK

The steering is locked, and all electrical systems are off. The key can be removed.

To lock the steering

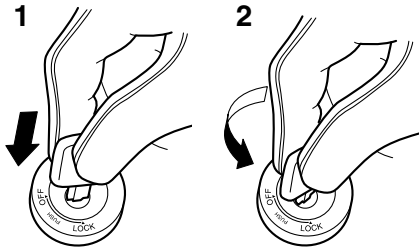

1. Push.
2. Turn.
 1. Turn the handlebars all the way to the left or right.
 2. Push the key in from the “OFF” position, and then turn it to “LOCK” while still pushing it.
 3. Remove the key.

To unlock the steering

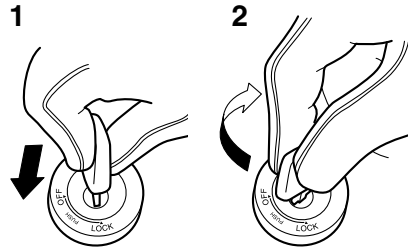

1. Push.
2. Turn.

Push the key into the main switch, and then turn it to “OFF” while still pushing it.

$p\leq$ (Parking)

The steering is locked, and the tail-lights, license plate light and auxiliary light are on. The hazard lights and turn signal lights can be turned on, but all other electrical systems are off. The key can be removed.

The steering must be locked before the key can be turned to “ $p\leq$ ”.

NOTICE

Do not use the parking position for an extended length of time, otherwise the battery may discharge.





ECA11020

EAU43460

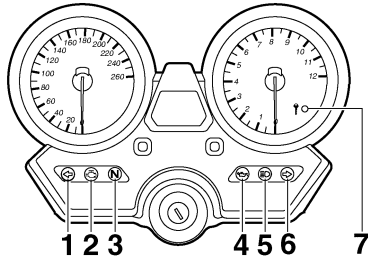
Indicator lights and warning lights

EAU49391



1. Left turn signal indicator light “”
2. Engine trouble warning light “”
3. Neutral indicator light “**N**”
4. Oil level warning light “”
5. High beam indicator light “”
6. Right turn signal indicator light “”
7. Immobilizer system indicator light

Turn signal indicator lights “” and “”

EAU11030

The corresponding indicator light flashes when the turn signal switch is pushed to the left or right.

Neutral indicator light “**N**”

EAU11060

This indicator light comes on when the transmission is in the neutral position.

High beam indicator light “”

EAU11080

This indicator light comes on when the high beam of the headlight is switched on.

Oil level warning light “”

EAU11123

This warning light comes on if the engine oil level is low. The electrical circuit of the warning light can be checked by turning the key to “ON”. The warning light should come on for a few seconds, and then go off. If the warning light does not come on initially when the key is turned to “ON”, or if the warning light remains on, have a Yamaha dealer check the electrical circuit.

TIP

Even if the oil level is sufficient, the warning light may flicker when riding on a slope or during sudden acceleration or deceleration, but this is not a malfunction.

Engine trouble warning light “”

EAU11534

This warning light comes on or flashes if a problem is detected in the electrical circuit monitoring the engine. If this occurs, have a Yamaha dealer check the self-diagnosis system. (See page 4-7 for an explanation of the self-diagnosis device.)

The electrical circuit of the warning light can be checked by turning the key to “ON”. The warning light should come on for a few seconds, and then go off. If the warning light does not come on initially when the key is turned to “ON”, or if the warning light remains on, have a Yamaha dealer check the electrical circuit.

INSTRUMENT AND CONTROL FUNCTIONS

4

EAU38624

Immobilizer system indicator light

The electrical circuit of the indicator light can be checked by turning the key to "ON". The indicator light should come on for a few seconds, and then go off.

If the indicator light does not come on initially when the key is turned to "ON", or if the indicator light remains on, have a Yamaha dealer check the electrical circuit.

When the key is turned to "OFF" and 30 seconds have passed, the indicator light will start flashing indicating the immobilizer system is enabled. After 24 hours have passed, the indicator light will stop flashing, however the immobilizer system is still enabled.

The self-diagnosis device also detects problems in the immobilizer system circuits. (See page 4-7 for an explanation of the self-diagnosis device.)

EAU11601

Speedometer

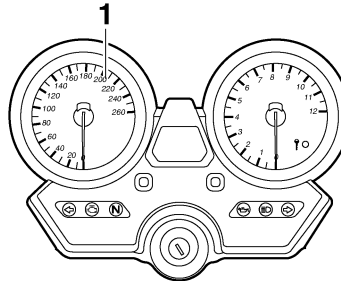

1. Speedometer

The speedometer shows the riding speed.

When the key is turned to "ON", the speedometer needle will sweep once across the speed range and then return to zero in order to test the electrical circuit.

EAU11872

Tachometer

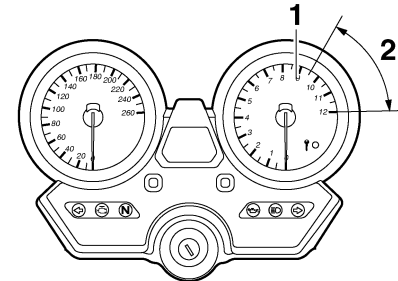

1. Tachometer
2. Tachometer red zone

The electric tachometer allows the rider to monitor the engine speed and keep it within the ideal power range.

When the key is turned to "ON", the tachometer needle will sweep once across the r/min range and then return to zero r/min in order to test the electrical circuit.

ECA10031

NOTICE

Do not operate the engine in the tachometer red zone.

Red zone: 9500 r/min and above

INSTRUMENT AND CONTROL FUNCTIONS

Multi-function display

EAU43249

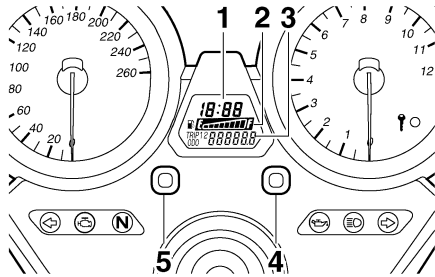

1. Clock
2. Fuel meter
3. Odometer/tripmeter/fuel reserve tripmeter
4. Reset button
5. Select button

EWA12312

WARNING

Be sure to stop the vehicle before making any setting changes to the multi-function display. Changing settings while riding can distract the operator and increase the risk of an accident.

The multi-function display is equipped with the following:

- an odometer

- two tripmeters (which show the distance traveled since they were last set to zero)
- a fuel reserve tripmeter (which shows the distance traveled on the fuel reserve)
- a fuel meter
- a clock
- a self-diagnosis device
- a display, speedometer, and tachometer brightness control mode

TIP

Be sure to turn the key to “ON” before using the select and reset buttons, except for setting the display, speedometer and tachometer brightness control mode.

Odometer and tripmeter modes

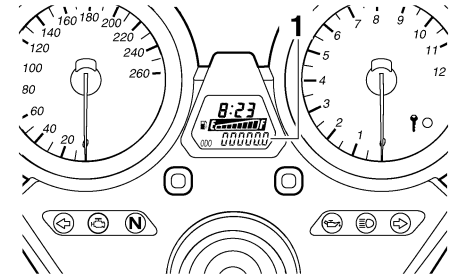

1. Odometer/tripmeter/fuel reserve tripmeter

Pushing the select button switches the display between the odometer mode “ODO” and the tripmeter modes “TRIP 1” and “TRIP 2” in the following order: ODO → TRIP 1 → TRIP 2 → ODO

When approximately 4.5 L (1.19 US gal, 0.99 Imp.gal) of fuel remains in the fuel tank, the display will automatically change to the fuel reserve tripmeter mode “TRIP F” and start counting the distance traveled from that point. In that case, pushing the select button switches the display between the various tripmeter and odometer modes in the following order:

TRIP F → ODO → TRIP 1 → TRIP 2 → TRIP F

INSTRUMENT AND CONTROL FUNCTIONS

To reset a tripmeter, select it by pushing the select button, and then push the reset button for at least two seconds. If you do not reset the fuel reserve tripmeter manually, it will reset itself automatically and the display will return to the prior mode after refueling and traveling 5 km (3 mi).

Fuel meter

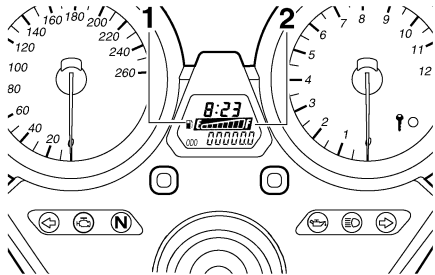

1. Fuel level warning indicator “”
2. Fuel meter

The fuel meter indicates the amount of fuel in the fuel tank. The display segments of the fuel meter disappear towards “E” (Empty) as the fuel level decreases. When the fuel level warning indicator “” starts flashing, refuel as soon as possible.

TIP

This fuel meter is equipped with a self-diagnosis system. If a problem is detected in the electrical circuit, the following cycle will be repeated until the malfunction is corrected: All the display segments and symbol “” will flash eight times, then go off for approximately 3 seconds. If this occurs, have a Yamaha dealer check the electrical circuit.

Clock mode

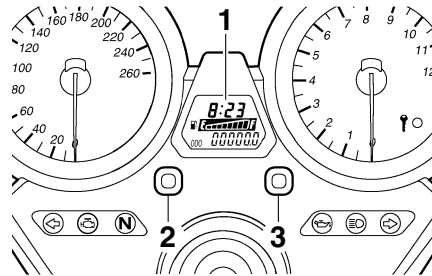

1. Clock
2. Select button
3. Reset button

To set the clock

1. Turn the key to “ON”.

2. Push the select button and reset button together for at least two seconds.
3. When the hour digits start flashing, push the reset button to set the hours.
4. Push the select button, and the minute digits will start flashing.
5. Push the reset button to set the minutes.
6. Push the select button and then release it to start the clock.

Self-diagnosis device

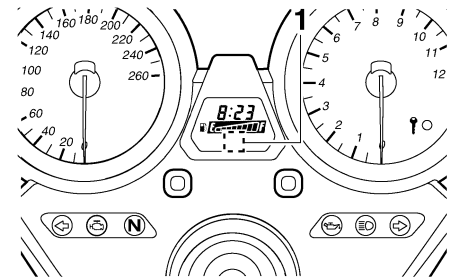

1. Error code display

This model is equipped with a self-diagnosis device for various electrical circuits.

INSTRUMENT AND CONTROL FUNCTIONS

If a problem is detected in any of those circuits, the engine trouble warning light will come on and the odometer/tripmeter display will indicate an error code.

If the display indicates any error codes, note the code number, and then have a Yamaha dealer check the vehicle.

The self-diagnosis device also detects problems in the immobilizer system circuits.

If a problem is detected in the immobilizer system circuits, the immobilizer system indicator light will flash and the display will indicate an error code.

TIP _____

If the display indicates error code 52, this could be caused by transponder interference. If this error code appears, try the following.

1. Use the code re-registering key to start the engine.

TIP _____

Make sure there are no other immobilizer keys close to the main switch, and do not keep more than one immobilizer key on the same key ring! Immobilizer

system keys may cause signal interference, which may prevent the engine from starting.

2. If the engine starts, turn it off and try starting the engine with the standard keys.
3. If one or both of the standard keys do not start the engine, take the vehicle, the code re-registering key and both standard keys to a Yamaha dealer and have the standard keys re-registered.

ECA11790

NOTICE _____

If the multi-function display indicates an error code, the vehicle should be checked as soon as possible in order to avoid engine damage.

Display, speedometer and tachometer brightness control mode

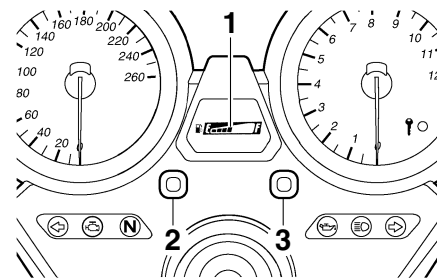

1. Brightness level
2. Select button
3. Reset button

This function allows you to adjust the brightness to suit the outside lighting conditions.

To adjust the brightness

1. Turn the key to “OFF”.
2. Push and hold the select button.
3. Turn the key to “ON”, and then release the select button after five seconds.
4. Push the reset button to select the desired brightness level.
5. Push the select button to confirm the selected brightness level.

INSTRUMENT AND CONTROL FUNCTIONS

Handlebar switches

Left

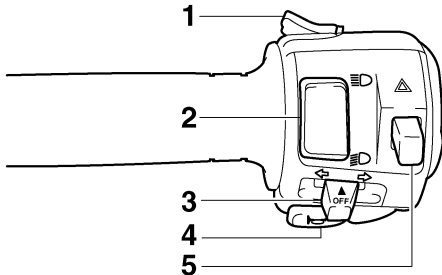

1. Pass switch “PASS”
2. Dimmer switch “ \equiv ○/ \equiv ○”
3. Turn signal switch “ \leftarrow / \rightarrow ”
4. Horn switch “ 📢 ”
5. Hazard switch “ \triangle ”

EAU12348

Right

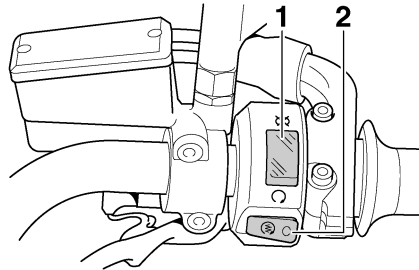

1. Engine stop switch “○/⊗”
2. Start switch “ 🌀 ”

EAU12360

Pass switch “PASS”

Press this switch to flash the headlight.

EAU12400

Dimmer switch “ \equiv ○/ \equiv ○”

Set this switch to “ \equiv ○” for the high beam and to “ \equiv ○” for the low beam.

EAU12460

Turn signal switch “ \leftarrow / \rightarrow ”

To signal a right-hand turn, push this switch to “ \rightarrow ”. To signal a left-hand turn, push this switch to “ \leftarrow ”. When released, the switch returns to the center

position. To cancel the turn signal lights, push the switch in after it has returned to the center position.

EAU12500

Horn switch “ 📢 ”

Press this switch to sound the horn.

EAU12660

Engine stop switch “○/⊗”

Set this switch to “○” before starting the engine. Set this switch to “⊗” to stop the engine in case of an emergency, such as when the vehicle overturns or when the throttle cable is stuck.

EAU12711

Start switch “ 🌀 ”

Push this switch to crank the engine with the starter. See page 6-1 for starting instructions prior to starting the engine.

EAU41700

The engine trouble warning light will come on when the key is turned to “ON” and the start switch is pushed, but this does not indicate a malfunction.

INSTRUMENT AND CONTROL FUNCTIONS

Hazard switch “ \triangle ”

EAU12733

With the key in the “ON” or “ $\rho \leq$ ” position, use this switch to turn on the hazard lights (simultaneous flashing of all turn signal lights).

The hazard lights are used in case of an emergency or to warn other drivers when your vehicle is stopped where it might be a traffic hazard.

ECA10061

NOTICE

Do not use the hazard lights for an extended length of time with the engine not running, otherwise the battery may discharge.

Clutch lever

EAU12830

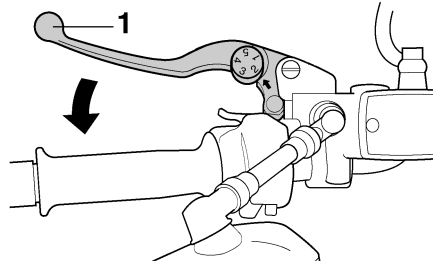

1. Clutch lever

The clutch lever is located at the left handlebar grip. To disengage the clutch, pull the lever toward the handlebar grip. To engage the clutch, release the lever. The lever should be pulled rapidly and released slowly for smooth clutch operation.

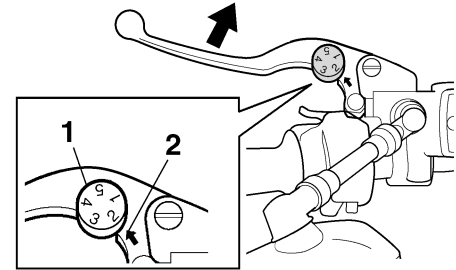

1. Clutch lever position adjusting dial
2. Arrow mark

The clutch lever is equipped with a clutch lever position adjusting dial. To adjust the distance between the clutch lever and the handlebar grip, turn the adjusting dial while holding the lever pushed away from the handlebar grip. Make sure that the appropriate setting on the adjusting dial is aligned with the arrow mark on the clutch lever. The clutch lever is equipped with a clutch switch, which is part of the ignition circuit cut-off system. (See page 4-22.)

INSTRUMENT AND CONTROL FUNCTIONS

Shift pedal

EAU12871

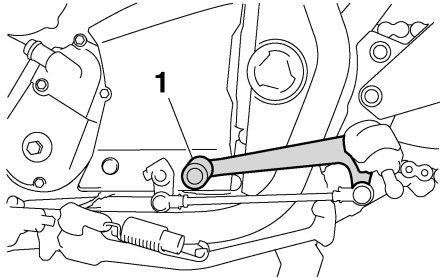

1. Shift pedal

The shift pedal is located on the left side of the motorcycle and is used in combination with the clutch lever when shifting the gears of the 5-speed constant-mesh transmission equipped on this motorcycle.

Brake lever

EAU26823

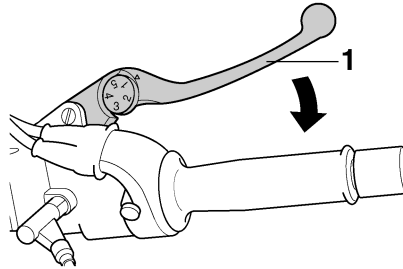

1. Brake lever

The brake lever is located at the right handlebar grip. To apply the front brake, pull the lever toward the handlebar grip.

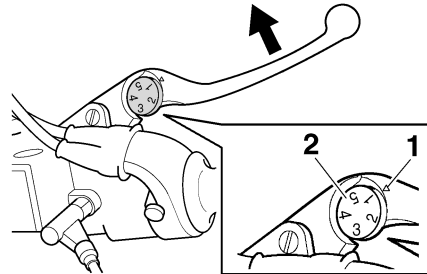

1. “△” mark
2. Brake lever position adjusting dial

The brake lever is equipped with a brake lever position adjusting dial. To adjust the distance between the brake lever and the handlebar grip, turn the adjusting dial while holding the lever pushed away from the handlebar grip. Make sure that the appropriate setting on the adjusting dial is aligned with the “△” mark on the brake lever.

Brake pedal

EAU12941

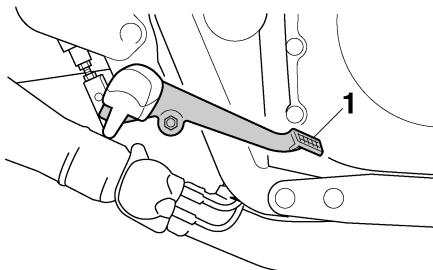

1. Brake pedal

The brake pedal is on the right side of the motorcycle. To apply the rear brake, press down on the brake pedal.

Fuel tank cap

EAU13074

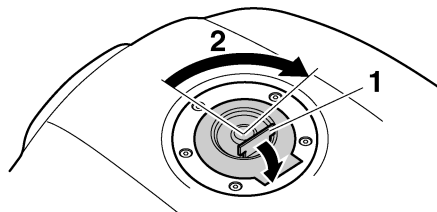

1. Fuel tank cap lock cover
2. Unlock.

To open the fuel tank cap

Open the fuel tank cap lock cover, insert the key into the lock, and then turn it 1/4 turn clockwise. The lock will be released and the fuel tank cap can be opened.

To close the fuel tank cap

1. Push the fuel tank cap into position with the key inserted in the lock.
2. Turn the key counterclockwise to the original position, remove it, and then close the lock cover.

TIP

The fuel tank cap cannot be closed unless the key is in the lock. In addition, the key cannot be removed if the cap is not properly closed and locked.

EWA11091

WARNING

Make sure that the fuel tank cap is properly closed after filling fuel. Leaking fuel is a fire hazard.

INSTRUMENT AND CONTROL FUNCTIONS

Fuel

Make sure there is sufficient gasoline in the tank.

EAU13221

EWA10881

WARNING

Gasoline and gasoline vapors are extremely flammable. To avoid fires and explosions and to reduce the risk of injury when refueling, follow these instructions.

1. Before refueling, turn off the engine and be sure that no one is sitting on the vehicle. Never refuel while smoking, or while in the vicinity of sparks, open flames, or other sources of ignition such as the pilot lights of water heaters and clothes dryers.
2. Do not overfill the fuel tank. When refueling, be sure to insert the pump nozzle into the fuel tank filler hole. Stop filling when the fuel reaches the bottom of the filler tube. Because fuel expands when it heats up, heat from the engine or the sun can cause fuel to spill out of the fuel tank.

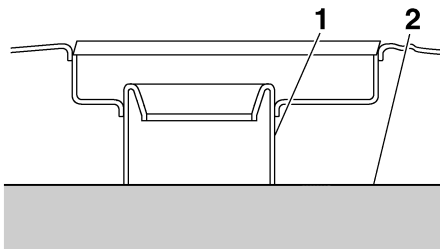

1. Fuel tank filler tube
2. Maximum fuel level

3. Wipe up any spilled fuel immediately. **NOTICE: Immediately wipe off spilled fuel with a clean, dry, soft cloth, since fuel may deteriorate painted surfaces or plastic parts.** (ECA10071)
4. Be sure to securely close the fuel tank cap.

EWA15151

WARNING

Gasoline is poisonous and can cause injury or death. Handle gasoline with care. Never siphon gasoline by mouth. If you should swallow some gasoline or inhale a lot of gasoline vapor, or get some gasoline in your eyes, see your doctor immedi-

ately. If gasoline spills on your skin, wash with soap and water. If gasoline spills on your clothing, change your clothes.

EAU43422

Recommended fuel:

Premium unleaded gasoline only

Fuel tank capacity:

21.0 L (5.55 US gal, 4.62 Imp.gal)

Fuel reserve amount (when the fuel level warning indicator flashes):

4.5 L (1.19 US gal, 0.99 Imp.gal)

ECA11400

NOTICE

Use only unleaded gasoline. The use of leaded gasoline will cause severe damage to internal engine parts, such as the valves and piston rings, as well as to the exhaust system.

Your Yamaha engine has been designed to use premium unleaded gasoline with a research octane number of 95 or higher. If knocking (or pinging) occurs, use a gasoline of a different

brand. Use of unleaded fuel will extend spark plug life and reduce maintenance costs.

Fuel tank breather/overflow hose

EAU39451

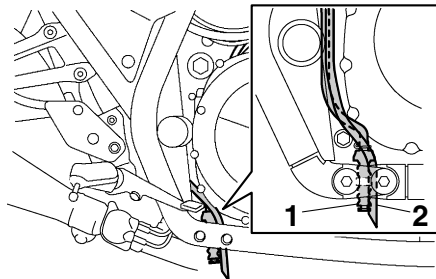

1. Fuel tank breather hose
2. Fuel tank overflow hose

Before operating the motorcycle:

- Check the fuel tank breather/overflow hose connection.
- Check the fuel tank breather/overflow hose for cracks or damage, and replace it if damaged.
- Make sure that the end of the fuel tank breather/overflow hose is not blocked, and clean it if necessary.

Catalytic converters

EAU13445

This vehicle is equipped with catalytic converters in the exhaust system.

EWA10862

⚠ WARNING

The exhaust system is hot after operation. To prevent a fire hazard or burns:

- Do not park the vehicle near possible fire hazards such as grass or other materials that easily burn.
- Park the vehicle in a place where pedestrians or children are not likely to touch the hot exhaust system.
- Make sure that the exhaust system has cooled down before doing any maintenance work.
- Do not allow the engine to idle more than a few minutes. Long idling can cause a build-up of heat.

INSTRUMENT AND CONTROL FUNCTIONS

ECA10701

EAU13900

NOTICE

Use only unleaded gasoline. The use of leaded gasoline will cause unreparable damage to the catalytic converter.

4

Seat

To remove the seat

1. Insert the key into the seat lock, and then turn it as shown.

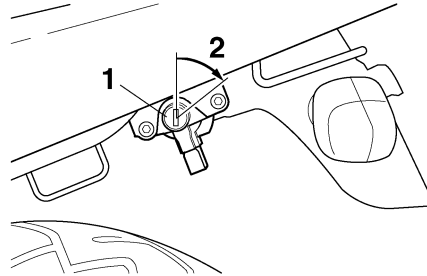

1. Seat lock
2. Unlock.

2. Pull the seat off.

To install the seat

1. Insert the projection on the front of the seat into the seat holder as shown.

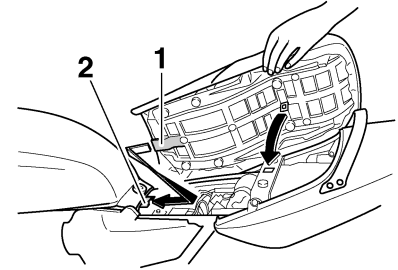

1. Projection
2. Seat holder

2. Push the rear of the seat down to lock it in place.
3. Remove the key.

TIP

Make sure that the seat is properly secured before riding.

INSTRUMENT AND CONTROL FUNCTIONS

Helmet holder

EAU14351

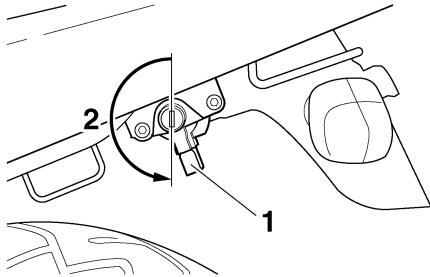

1. Helmet holder
2. Unlock.

To open the helmet holder, insert the key into the seat lock, and then turn the key as shown.

To lock the helmet holder, turn the key to the original position, and then remove it. **WARNING! Never ride with a helmet attached to the helmet holder, since the helmet may hit objects, causing loss of control and possibly an accident.** [EWA10161]

Storage compartment

EAU14453

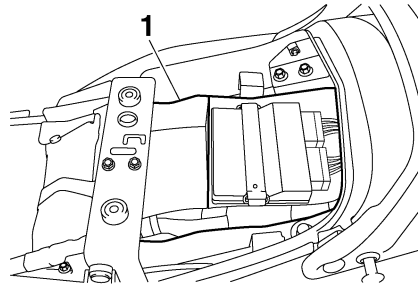

1. Storage compartment

The storage compartment is located under the seat. (See page 4-15.)

When storing the Owner's Manual or other documents in the storage compartment, be sure to wrap them in a plastic bag so that they will not get wet. When washing the vehicle, be careful not to let any water enter the storage compartment.

EWA10961

WARNING

- Do not exceed the load limit of 3 kg (7 lb) for the storage compartment.

- Do not exceed the maximum load of 205 kg (452 lb) for the vehicle.

INSTRUMENT AND CONTROL FUNCTIONS

Adjusting the front fork

EAU14743

EWA10180

WARNING

Always adjust both fork legs equally, otherwise poor handling and loss of stability may result.

This front fork is equipped with spring preload adjusting bolts, rebound damping force adjusting screws and compression damping force adjusting screws.

NOTICE

To avoid damaging the mechanism, do not attempt to turn beyond the maximum or minimum settings.

Spring preload

To increase the spring preload and thereby harden the suspension, turn the adjusting bolt on each fork leg in direction (a). To decrease the spring preload and thereby soften the suspension, turn the adjusting bolt on each fork leg in direction (b).

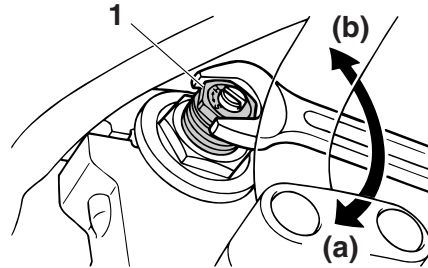

1. Spring preload adjusting bolt

Align the appropriate groove on the adjusting mechanism with the top of the front fork cap bolt.

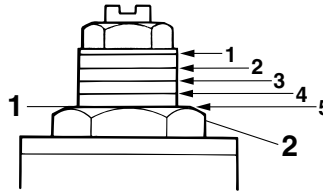

1. Current setting
2. Front fork cap bolt

Spring preload setting:

Minimum (soft):

8

Standard:

5

Maximum (hard):

1

Rebound damping force

To increase the rebound damping force and thereby harden the rebound damping, turn the adjusting screw on each fork leg in direction (a). To decrease the rebound damping force and thereby soften the rebound damping, turn the adjusting screw on each fork leg in direction (b).

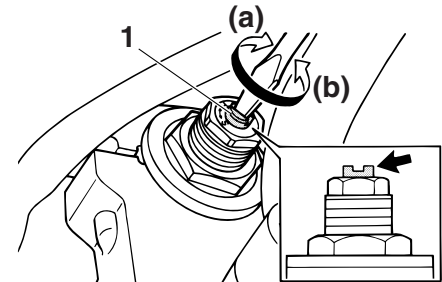

1. Rebound damping force adjusting screw

Rebound damping setting:

Minimum (soft):

10 click(s) in direction (b)*

Standard:

5 click(s) in direction (b)*

Maximum (hard):

1 click(s) in direction (b)*

* With the adjusting screw fully turned in direction (a)

Compression damping setting:

Minimum (soft):

13 click(s) in direction (b)*

Standard:

6 click(s) in direction (b)*

Maximum (hard):

1 click(s) in direction (b)*

* With the adjusting screw fully turned in direction (a)

Adjusting the shock absorber assembly

EWA10210



Always adjust both shock absorber assemblies equally, otherwise poor handling and loss of stability may result.

Compression damping force

To increase the compression damping force and thereby harden the compression damping, turn the adjusting screw on each fork leg in direction (a). To decrease the compression damping force and thereby soften the compression damping, turn the adjusting screw on each fork leg in direction (b).

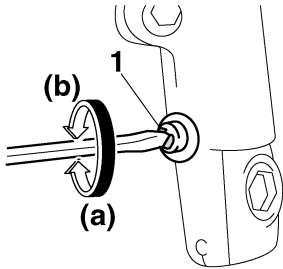

1. Compression damping force adjusting screw

TIP

Although the total number of clicks of a damping force adjusting mechanism may not exactly match the above specifications due to small differences in production, the actual number of clicks always represents the entire adjusting range. To obtain a precise adjustment, it would be advisable to check the number of clicks of each damping force adjusting mechanism and to modify the specifications as necessary.

Each shock absorber assembly is equipped with a spring preload adjusting ring and rebound and compression damping force adjusting knobs.

Spring preload

Adjust the spring preload as follows.

1. Loosen the lock screw 1/2 turn counterclockwise.

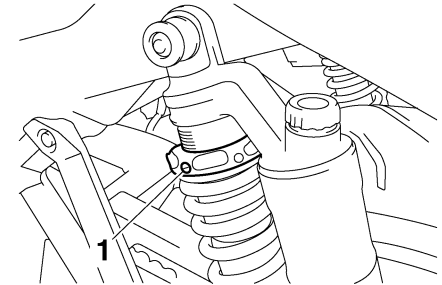

1. Lock screw

INSTRUMENT AND CONTROL FUNCTIONS

2. To increase the spring preload and thereby harden the suspension, turn the adjusting ring in direction (a). To decrease the spring preload and thereby soften the suspension, turn the adjusting ring in direction (b).

- Use the special wrench included in the owner's tool kit to make this adjustment.
- The spring preload setting is determined by measuring distance A, shown in the illustration. The longer distance A is, the higher the spring preload; the shorter distance A is, the lower the spring preload. With each complete turn of the adjusting ring, distance A changes by 1.5 mm (0.06 in).
- Be sure to turn the adjusting ring so that the lock screw is facing outward.

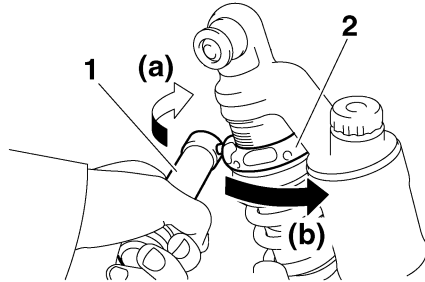

1. Special wrench
2. Spring preload adjusting ring

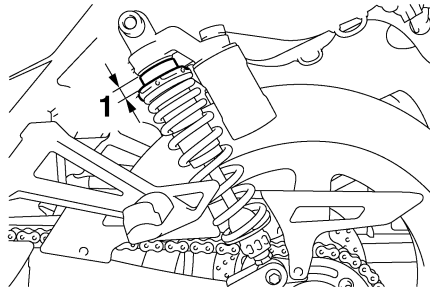

1. Distance A

Spring preload setting:

- Minimum (soft):
Distance A = 0 mm (0 in)
- Standard:
Distance A = 17 mm (0.67 in)
- Maximum (hard):
Distance A = 28 mm (1.10 in)

3. Tighten the lock screw to the specified torque.

Tightening torque:

- Lock screw:
0.1 Nm (0.01 m·kgf, 0.07 ft·lbf)

Rebound damping force

To increase the rebound damping force and thereby harden the rebound damping, turn the adjusting knob in direction (a). To decrease the rebound damping force and thereby soften the rebound damping, turn the adjusting knob in direction (b).

INSTRUMENT AND CONTROL FUNCTIONS

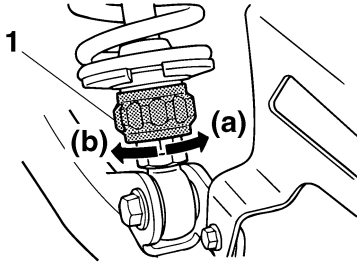

1. Rebound damping force adjusting knob

Rebound damping setting:

Minimum (soft):

36 click(s) in direction (b)*

Standard:

10 click(s) in direction (b)*

Maximum (hard):

1 click(s) in direction (b)*

* With the adjusting knob fully turned in direction (a)

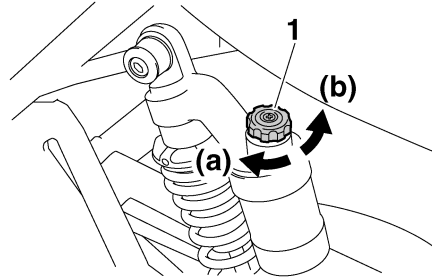

1. Compression damping force adjusting knob

Compression damping setting:

Minimum (soft):

20 click(s) in direction (b)*

Standard:

16 click(s) in direction (b)*

Maximum (hard):

1 click(s) in direction (b)*

* With the adjusting knob fully turned in direction (a)

Compression damping force

To increase the compression damping force and thereby harden the compression damping, turn the adjusting knob in direction (a). To decrease the compression damping force and thereby soften the compression damping, turn the adjusting knob in direction (b).

TIP

To obtain a precise adjustment, it is advisable to check the actual total number of clicks or turns of each damping force adjusting mechanism. This adjustment range may not exactly match the specifications listed due to small differences in production.

EWA10231

⚠ WARNING

These shock absorber assemblies contain highly pressurized nitrogen gas. Read and understand the following information before handling the shock absorber assemblies.

- Do not tamper with or attempt to open the cylinder assemblies.
- Do not subject the shock absorber assemblies to an open flame or other high heat source. This may cause the unit to explode due to excessive gas pressure.
- Do not deform or damage the cylinders in any way. Cylinder damage will result in poor damping performance.

NOTICE

To avoid damaging the mechanism, do not attempt to turn beyond the maximum or minimum settings.

ECA10101

INSTRUMENT AND CONTROL FUNCTIONS

- Do not dispose of a damaged or worn-out shock absorber assembly yourself. Take the shock absorber assembly to a Yamaha dealer for any service.

Luggage strap holders

EAU43442

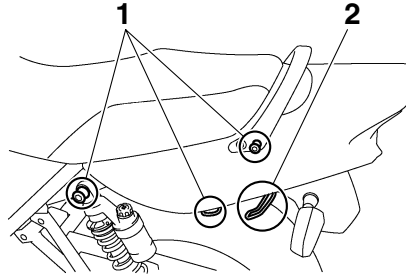

1. Luggage strap holder
2. Retractable luggage strap holder

There are four luggage strap holders on each side of the vehicle, one of which is retractable. The retractable luggage strap holders can be turned out for easier access.

EXUP system

EAU15282

This model is equipped with Yamaha's EXUP (EXhaust Ultimate Power valve) system. This system boosts engine power by means of a valve that regulates the inner diameter of the exhaust pipe. The EXUP system valve is constantly adjusted in accordance with the engine speed by a computer-controlled servomotor.

ECA10191

NOTICE

- The EXUP system has been set and extensively tested at the Yamaha factory. Changing these settings without sufficient technical knowledge may result in poor performance of or damage to the engine.
- If the EXUP system cannot be heard when the main switch is turned on, have a Yamaha dealer check it.

Sidestand

EAU15304

The sidestand is located on the left side of the frame. Raise the sidestand or lower it with your foot while holding the vehicle upright.

TIP

The built-in sidestand switch is part of the ignition circuit cut-off system, which cuts the ignition in certain situations. (See page 4-22 for an explanation of the ignition circuit cut-off system.)

EWA10241

WARNING

The vehicle must not be ridden with the sidestand down, or if the sidestand cannot be properly moved up (or does not stay up), otherwise the sidestand could contact the ground and distract the operator, resulting in a possible loss of control. Yamaha's ignition circuit cut-off system has been designed to assist the operator in fulfilling the responsibility of raising the sidestand before starting off. Therefore, check

this system regularly and have a Yamaha dealer repair it if it does not function properly.

EAU44902

Ignition circuit cut-off system

The ignition circuit cut-off system (comprising the sidestand switch, clutch switch and neutral switch) has the following functions.

- It prevents starting when the transmission is in gear and the sidestand is up, but the clutch lever is not pulled.
- It prevents starting when the transmission is in gear and the clutch lever is pulled, but the sidestand is still down.
- It cuts the running engine when the transmission is in gear and the sidestand is moved down.

Periodically check the operation of the ignition circuit cut-off system according to the following procedure.

INSTRUMENT AND CONTROL FUNCTIONS

4

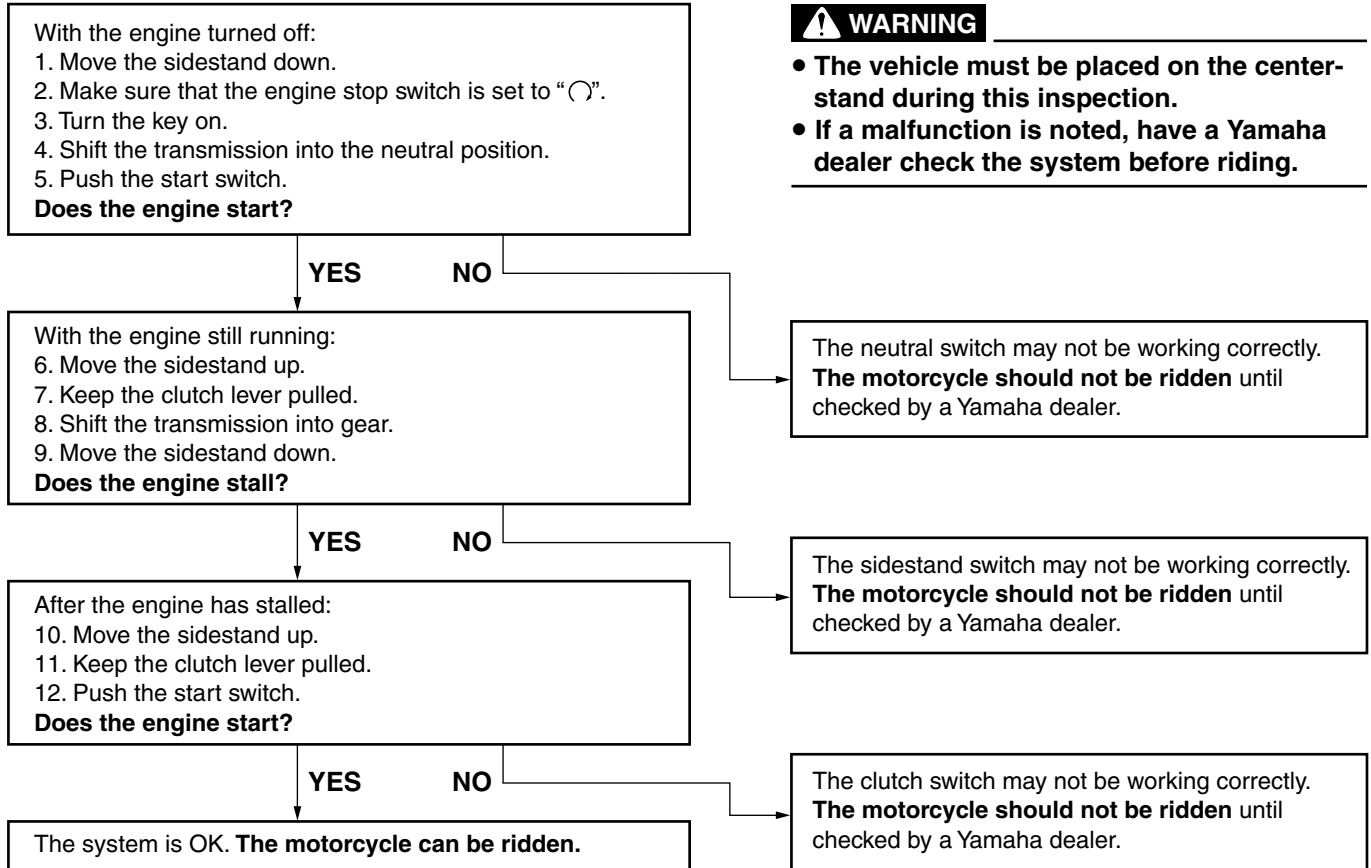

FOR YOUR SAFETY – PRE-OPERATION CHECKS

EAU15596

Inspect your vehicle each time you use it to make sure the vehicle is in safe operating condition. Always follow the inspection and maintenance procedures and schedules described in the Owner's Manual.

EWA11151

WARNING

Failure to inspect or maintain the vehicle properly increases the possibility of an accident or equipment damage. Do not operate the vehicle if you find any problem. If a problem cannot be corrected by the procedures provided in this manual, have the vehicle inspected by a Yamaha dealer.

Before using this vehicle, check the following points:

ITEM	CHECKS	PAGE
Fuel	<ul style="list-style-type: none">• Check fuel level in fuel tank.• Refuel if necessary.• Check fuel line for leakage.• Check fuel tank breather/overflow hose for obstructions, cracks or damage, and check hose connection.	4-13, 4-14
Engine oil	<ul style="list-style-type: none">• Check oil level in engine.• If necessary, add recommended oil to specified level.• Check vehicle for oil leakage.	7-10
Front brake	<ul style="list-style-type: none">• Check operation.• If soft or spongy, have Yamaha dealer bleed hydraulic system.• Check brake pads for wear.• Replace if necessary.• Check fluid level in reservoir.• If necessary, add recommended brake fluid to specified level.• Check hydraulic system for leakage.	7-19, 7-20

FOR YOUR SAFETY – PRE-OPERATION CHECKS

ITEM	CHECKS	PAGE
Rear brake	<ul style="list-style-type: none"> • Check operation. • If soft or spongy, have Yamaha dealer bleed hydraulic system. • Check brake pads for wear. • Replace if necessary. • Check fluid level in reservoir. • If necessary, add recommended brake fluid to specified level. • Check hydraulic system for leakage. 	7-19, 7-20
Clutch	<ul style="list-style-type: none"> • Check operation. • If soft or spongy, have Yamaha dealer bleed hydraulic system. • Check fluid level in reservoir. • If necessary, add recommended fluid to specified level. • Check hydraulic system for leakage. 	7-18, 7-20
Throttle grip	<ul style="list-style-type: none"> • Make sure that operation is smooth. • Check throttle grip free play. • If necessary, have Yamaha dealer adjust throttle grip free play and lubricate cable and grip housing. 	7-14, 7-24
Control cables	<ul style="list-style-type: none"> • Make sure that operation is smooth. • Lubricate if necessary. 	7-24
Drive chain	<ul style="list-style-type: none"> • Check chain slack. • Adjust if necessary. • Check chain condition. • Lubricate if necessary. 	7-22, 7-23
Wheels and tires	<ul style="list-style-type: none"> • Check for damage. • Check tire condition and tread depth. • Check air pressure. • Correct if necessary. 	7-15, 7-17
Brake and shift pedals	<ul style="list-style-type: none"> • Make sure that operation is smooth. • Lubricate pedal pivoting points if necessary. 	7-24
Brake and clutch levers	<ul style="list-style-type: none"> • Make sure that operation is smooth. • Lubricate lever pivoting points if necessary. 	7-25
Centerstand, sidestand	<ul style="list-style-type: none"> • Make sure that operation is smooth. • Lubricate pivots if necessary. 	7-26

FOR YOUR SAFETY – PRE-OPERATION CHECKS

ITEM	CHECKS	PAGE
Chassis fasteners	<ul style="list-style-type: none">• Make sure that all nuts, bolts and screws are properly tightened.• Tighten if necessary.	—
Instruments, lights, signals and switches	<ul style="list-style-type: none">• Check operation.• Correct if necessary.	—
Sidestand switch	<ul style="list-style-type: none">• Check operation of ignition circuit cut-off system.• If system is not working correctly, have Yamaha dealer check vehicle.	4-22

OPERATION AND IMPORTANT RIDING POINTS

EAU15951

EAU46632

EAU33729

Read the Owner's Manual carefully to become familiar with all controls. If there is a control or function you do not understand, ask your Yamaha dealer.

EWA10271

WARNING

Failure to familiarize yourself with the controls can lead to loss of control, which could cause an accident or injury.

6

TIP

This model is equipped with:

- a lean angle sensor to stop the engine in case of a turnover. In this case, the multi-function display indicates error code 30, but this is not a malfunction. Turn the key to "OFF" and then to "ON" to clear the error code. Failing to do so will prevent the engine from starting even though the engine will crank when pushing the start switch.
- an engine auto-stop system. The engine stops automatically if left idling for 20 minutes. In this case, the multi-function display indicates error code 70, but this is not a malfunction. Push the start switch to clear the error code and to restart the engine.

Starting the engine

In order for the ignition circuit cut-off system to enable starting, one of the following conditions must be met:

- The transmission is in the neutral position.
- The transmission is in gear with the clutch lever pulled and the sidestand up.

See page 4-22 for more information.

1. Turn the key to "ON" and make sure that the engine stop switch is set to "○".

The following warning lights and indicator light should come on for a few seconds, then go off.

- Oil level warning light
- Engine trouble warning light
- Immobilizer system indicator light

ECA11833

NOTICE

If a warning or indicator light does not come on initially when the key is turned to "ON", or if a warning or in-

OPERATION AND IMPORTANT RIDING POINTS

indicator light remains on, see page 4-4 for the corresponding warning and indicator light circuit check.

2. Shift the transmission into the neutral position. The neutral indicator light should come on. If not, ask a Yamaha dealer to check the electrical circuit.
3. Start the engine by pushing the start switch.

If the engine fails to start, release the start switch, wait a few seconds, and then try again. Each starting attempt should be as short as possible to preserve the battery. Do not crank the engine more than 10 seconds on any one attempt.

ECA11042

NOTICE

For maximum engine life, never accelerate hard when the engine is cold!

Shifting

EAU16671

ECA10260

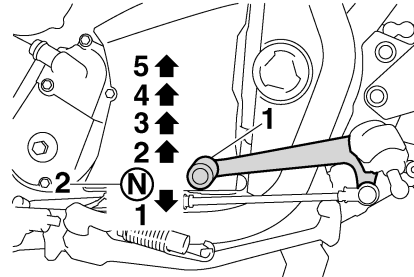

1. Shift pedal
2. Neutral position

Shifting gears lets you control the amount of engine power available for starting off, accelerating, climbing hills, etc.

The gear positions are shown in the illustration.

TIP

To shift the transmission into the neutral position, press the shift pedal repeatedly until it reaches the end of its travel, and then slightly raise it.

NOTICE

- Even with the transmission in the neutral position, do not coast for long periods of time with the engine off, and do not tow the motorcycle for long distances. The transmission is properly lubricated only when the engine is running. Inadequate lubrication may damage the transmission.
- Always use the clutch while changing gears to avoid damaging the engine, transmission, and drive train, which are not designed to withstand the shock of forced shifting.

OPERATION AND IMPORTANT RIDING POINTS

Tips for reducing fuel consumption

EAU16810

Fuel consumption depends largely on your riding style. Consider the following tips to reduce fuel consumption:

- Shift up swiftly, and avoid high engine speeds during acceleration.
- Do not rev the engine while shifting down, and avoid high engine speeds with no load on the engine.
- Turn the engine off instead of letting it idle for an extended length of time (e.g., in traffic jams, at traffic lights or at railroad crossings).

Engine break-in

EAU16841

There is never a more important period in the life of your engine than the period between 0 and 1600 km (1000 mi). For this reason, you should read the following material carefully.

Since the engine is brand new, do not put an excessive load on it for the first 1600 km (1000 mi). The various parts in the engine wear and polish themselves to the correct operating clearances. During this period, prolonged full-throttle operation or any condition that might result in engine overheating must be avoided.

1600 km (1000 mi) and beyond

The vehicle can now be operated normally.

ECA10310

NOTICE

- Keep the engine speed out of the tachometer red zone.
- If any engine trouble should occur during the engine break-in period, immediately have a Yamaha dealer check the vehicle.

EAU17093

0–1000 km (0–600 mi)

Avoid prolonged operation above 4800 r/min. **NOTICE: After 1000 km (600 mi) of operation, the engine oil must be changed and the oil filter cartridge or element replaced.** [ECA10302]

1000–1600 km (600–1000 mi)

Avoid prolonged operation above 5700 r/min.

EAU17213

Parking

When parking, stop the engine, and then remove the key from the main switch.

EWA10311

WARNING

- **Since the engine and exhaust system can become very hot, park in a place where pedestrians or children are not likely to touch them and be burned.**
 - **Do not park on a slope or on soft ground, otherwise the vehicle may overturn, increasing the risk of a fuel leak and fire.**
 - **Do not park near grass or other flammable materials which might catch fire.**
-

PERIODIC MAINTENANCE AND ADJUSTMENT

EAU17243

EWA15121

EAU17302

Periodic inspection, adjustment, and lubrication will keep your vehicle in the safest and most efficient condition possible. Safety is an obligation of the vehicle owner/operator. The most important points of vehicle inspection, adjustment, and lubrication are explained on the following pages.

The intervals given in the periodic maintenance charts should be simply considered as a general guide under normal riding conditions. However, depending on the weather, terrain, geographical location, and individual use, the maintenance intervals may need to be shortened.

WARNING

Turn off the engine when performing maintenance unless otherwise specified.

- **A running engine has moving parts that can catch on body parts or clothing and electrical parts that can cause shocks or fires.**
- **Running the engine while servicing can lead to eye injury, burns, fire, or carbon monoxide poisoning – possibly leading to death. See page 2-1 for more information about carbon monoxide.**

Emission controls not only function to ensure cleaner air, but are also vital to proper engine operation and maximum performance. In the following periodic maintenance charts, the services related to emissions control are grouped separately. These services require specialized data, knowledge, and equipment. Maintenance, replacement, or repair of the emission control devices and systems may be performed by any repair establishment or individual that is certified (if applicable). Yamaha dealers are trained and equipped to perform these particular services.

7

EWA10321

EWA15460

WARNING

Failure to properly maintain the vehicle or performing maintenance activities incorrectly may increase your risk of injury or death during service or while using the vehicle. If you are not familiar with vehicle service, have a Yamaha dealer perform service.

WARNING

Brake discs, calipers, drums, and linings can become very hot during use. To avoid possible burns, let brake components cool before touching them.

EAU17381

Owner's tool kit

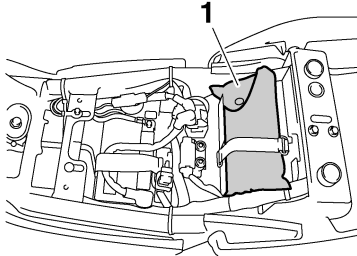

1. Owner's tool kit

The owner's tool kit is located under the seat. (See page 4-15.)

The service information included in this manual and the tools provided in the owner's tool kit are intended to assist you in the performance of preventive maintenance and minor repairs. However, additional tools such as a torque wrench may be necessary to perform certain maintenance work correctly.

TIP _____

If you do not have the tools or experience required for a particular job, have a Yamaha dealer perform it for you.

PERIODIC MAINTENANCE AND ADJUSTMENT

EAU46861

TIP

- The annual checks must be performed every year, except if a kilometer-based maintenance, or for the UK, a mileage-based maintenance, is performed instead.
- From 50000 km (30000 mi), repeat the maintenance intervals starting from 10000 km (6000 mi).
- Items marked with an asterisk should be performed by a Yamaha dealer as they require special tools, data and technical skills.

EAU46910

Periodic maintenance chart for the emission control system

NO.	ITEM	CHECK OR MAINTENANCE JOB	ODOMETER READING					ANNUAL CHECK
			1000 km (600 mi)	10000 km (6000 mi)	20000 km (12000 mi)	30000 km (18000 mi)	40000 km (24000 mi)	
1	* Fuel line	<ul style="list-style-type: none"> • Check fuel hoses for cracks or damage. 		√	√	√	√	√
2	Spark plugs	<ul style="list-style-type: none"> • Check condition. • Clean and regap. 		√		√		
		<ul style="list-style-type: none"> • Replace. 			√		√	
3	* Valves	<ul style="list-style-type: none"> • Check valve clearance. • Adjust. 	Every 20000 km (12000 mi)					
4	* Fuel injection system	<ul style="list-style-type: none"> • Adjust synchronization. 		√	√	√	√	√
5	* Muffler and exhaust pipe	<ul style="list-style-type: none"> • Check the screw clamp(s) for looseness. 	√	√	√	√	√	
6	* Air induction system	<ul style="list-style-type: none"> • Check the air cut-off valve, reed valve, and hose for damage. • Replace any damaged parts if necessary. 		√	√	√	√	√

PERIODIC MAINTENANCE AND ADJUSTMENT

EAU1770C

General maintenance and lubrication chart

NO.	ITEM	CHECK OR MAINTENANCE JOB	ODOMETER READING					ANNUAL CHECK
			1000 km (600 mi)	10000 km (6000 mi)	20000 km (12000 mi)	30000 km (18000 mi)	40000 km (24000 mi)	
1	Air filter element	• Replace.					√	
2	* Clutch	• Check operation, fluid level and vehicle for fluid leakage.	√	√	√	√	√	
3	* Front brake	• Check operation, fluid level and vehicle for fluid leakage.	√	√	√	√	√	√
		• Replace brake pads.	Whenever worn to the limit					
4	* Rear brake	• Check operation, fluid level and vehicle for fluid leakage.	√	√	√	√	√	√
		• Replace brake pads.	Whenever worn to the limit					
5	* Brake hoses	• Check for cracks or damage.		√	√	√	√	√
		• Replace.	Every 4 years					
6	* Wheels	• Check runout and for damage.		√	√	√	√	
7	* Tires	• Check tread depth and for damage. • Replace if necessary. • Check air pressure. • Correct if necessary.		√	√	√	√	√
8	* Wheel bearings	• Check bearing for looseness or damage.		√	√	√	√	
9	* Swingarm	• Check operation and for excessive play.		√	√	√	√	
		• Lubricate with lithium-soap-based grease.	Every 50000 km (30000 mi)					

7

PERIODIC MAINTENANCE AND ADJUSTMENT

NO.	ITEM	CHECK OR MAINTENANCE JOB	ODOMETER READING					ANNUAL CHECK
			1000 km (600 mi)	10000 km (6000 mi)	20000 km (12000 mi)	30000 km (18000 mi)	40000 km (24000 mi)	
10	Drive chain	<ul style="list-style-type: none"> • Check chain slack, alignment and condition. • Adjust and lubricate chain with a special O-ring chain lubricant thoroughly. 	Every 1000 km (600 mi) and after washing the motorcycle, riding in the rain or riding in wet areas					
11	* Steering bearings	<ul style="list-style-type: none"> • Check bearing play and steering for roughness. • Lubricate with lithium-soap-based grease. 	√	√	√	√	√	
12	* Chassis fasteners	<ul style="list-style-type: none"> • Make sure that all nuts, bolts and screws are properly tightened. 		√	√	√	√	√
13	Brake lever pivot shaft	<ul style="list-style-type: none"> • Lubricate with silicone grease. 		√	√	√	√	√
14	Brake pedal pivot shaft	<ul style="list-style-type: none"> • Lubricate with lithium-soap-based grease. 		√	√	√	√	√
15	Clutch lever pivot shaft	<ul style="list-style-type: none"> • Lubricate with silicone grease. 		√	√	√	√	√
16	Shift pedal pivot shaft	<ul style="list-style-type: none"> • Lubricate with lithium-soap-based grease. 		√	√	√	√	√
17	Sidestand, center-stand	<ul style="list-style-type: none"> • Check operation. • Lubricate with lithium-soap-based grease. 		√	√	√	√	√
18	* Sidestand switch	<ul style="list-style-type: none"> • Check operation. 	√	√	√	√	√	√
19	* Front fork	<ul style="list-style-type: none"> • Check operation and for oil leakage. 		√	√	√	√	
20	* Shock absorber assemblies	<ul style="list-style-type: none"> • Check operation and shock absorbers for oil leakage. 		√	√	√	√	

PERIODIC MAINTENANCE AND ADJUSTMENT

NO.	ITEM	CHECK OR MAINTENANCE JOB	ODOMETER READING					ANNUAL CHECK
			1000 km (600 mi)	10000 km (6000 mi)	20000 km (12000 mi)	30000 km (18000 mi)	40000 km (24000 mi)	
21	Engine oil	<ul style="list-style-type: none"> • Change. • Check oil level and vehicle for oil leakage. 	√	√	√	√	√	√
22	Engine oil filter element	<ul style="list-style-type: none"> • Replace. 	√		√		√	
23	* Front and rear brake switches	<ul style="list-style-type: none"> • Check operation. 	√	√	√	√	√	√
24	Moving parts and cables	<ul style="list-style-type: none"> • Lubricate. 		√	√	√	√	√
25	* Throttle grip	<ul style="list-style-type: none"> • Check operation. • Check throttle grip free play, and adjust if necessary. • Lubricate cable and grip housing. 		√	√	√	√	√
26	* Lights, signals and switches	<ul style="list-style-type: none"> • Check operation. • Adjust headlight beam. 	√	√	√	√	√	√

EAU36771

TIP

- Air filter
 - This model's air filter is equipped with a disposable oil-coated paper element, which must not be cleaned with compressed air to avoid damaging it.
 - The air filter element needs to be replaced more frequently when riding in unusually wet or dusty areas.
- Hydraulic brake and clutch service
 - Regularly check and, if necessary, correct the brake fluid and clutch fluid levels.
 - Every two years replace the internal components of the brake master cylinders and calipers as well as clutch master and release cylinders, and change the brake and clutch fluids.

PERIODIC MAINTENANCE AND ADJUSTMENT

- Replace the brake and clutch hoses every four years and if cracked or damaged.
-

PERIODIC MAINTENANCE AND ADJUSTMENT

Removing and installing panels

EAU18771

The panels shown need to be removed to perform some of the maintenance jobs described in this chapter. Refer to this section each time a panel needs to be removed and installed.

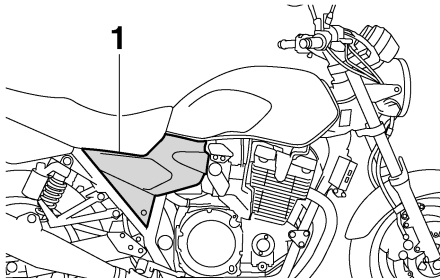

1. Panel A

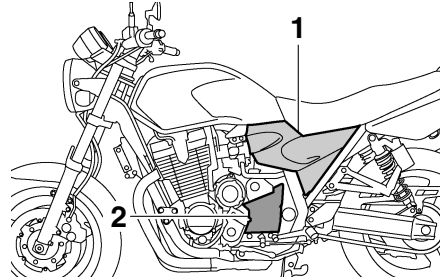

1. Panel B
2. Panel C

Panels A and B

EAU43261

To remove a panel

1. Remove the seat. (See page 4-15.)
2. Remove the bolt, and then pull the panel off as shown.

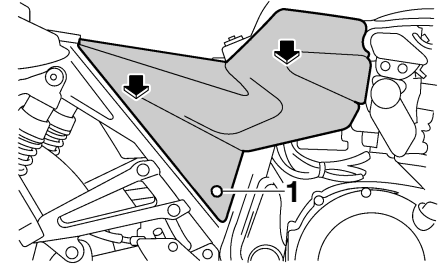

1. Bolt

To install a panel

1. Place the panel in its original position, and then install the bolt.

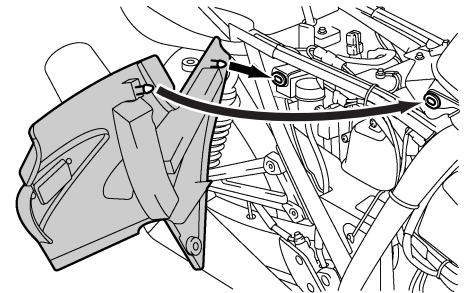

2. Install the seat.

PERIODIC MAINTENANCE AND ADJUSTMENT

Panel C

EAU19193

To remove the panel

Remove the bolts, and then take the panel off.

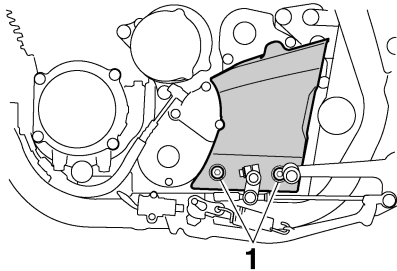

1. Bolt

To install the panel

Place the panel in the original position, and then install the bolts.

7

EAU19545

Checking the spark plugs

The spark plugs are important engine components, which are easy to check. Since heat and deposits will cause any spark plug to slowly erode, the spark plugs should be removed and checked in accordance with the periodic maintenance and lubrication chart. In addition, the condition of the spark plugs can reveal the condition of the engine.

To remove a spark plug

1. Remove the spark plug cap.

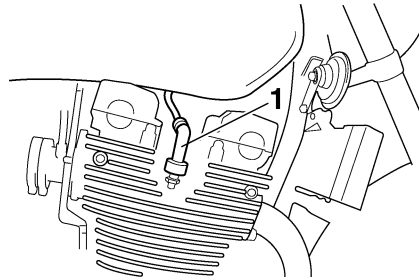

1. Spark plug cap

2. Remove the spark plug as shown, with the spark plug wrench included in the owner's tool kit.

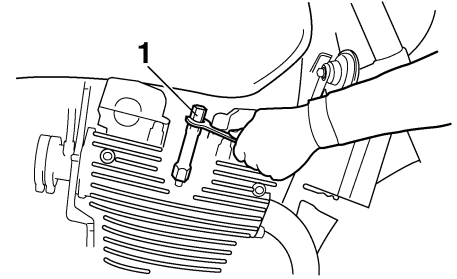

1. Spark plug wrench

To check the spark plugs

1. Check that the porcelain insulator around the center electrode on each spark plug is a medium-to-light tan (the ideal color when the vehicle is ridden normally).
2. Check that all spark plugs installed in the engine have the same color.

TIP

If any spark plug shows a distinctly different color, the engine could be operating improperly. Do not attempt to diagnose such problems yourself. Instead, have a Yamaha dealer check the vehicle.

PERIODIC MAINTENANCE AND ADJUSTMENT

EAU1969B

3. Check each spark plug for electrode erosion and excessive carbon or other deposits, and replace it if necessary.

Specified spark plug:
NGK/DPR8EA-9

4. Measure the spark plug gap with a wire thickness gauge and, if necessary, adjust the gap to specification.

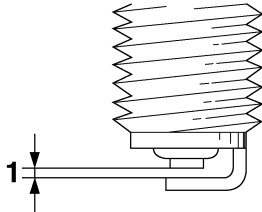

1. Spark plug gap

Spark plug gap:
0.8–0.9 mm (0.031–0.035 in)

To install a spark plug

1. Clean the surface of the spark plug gasket and its mating surface, and then wipe off any grime from the spark plug threads.
2. Install the spark plug with the spark plug wrench, and then tighten it to the specified torque.

Tightening torque:

Spark plug:
18 Nm (1.8 m·kgf, 13 ft·lbf)

TIP

If a torque wrench is not available when installing a spark plug, a good estimate of the correct torque is 1/4–1/2 turn past finger tight. However, the spark plug should be tightened to the specified torque as soon as possible.

3. Install the spark plug cap.

Engine oil and oil filter element

The engine oil level should be checked before each ride. In addition, the oil must be changed and the oil filter element replaced at the intervals specified in the periodic maintenance and lubrication chart. A slight tilt to the side can result in a false reading.

To check the engine oil level

1. Place the vehicle on the center-stand.
2. Start the engine, warm it up for several minutes, and then turn it off.
3. Wait a few minutes until the oil settles, and then check the oil level through the check window located at the bottom-right side of the crankcase.

TIP

The engine oil should be between the minimum and maximum level marks.

PERIODIC MAINTENANCE AND ADJUSTMENT

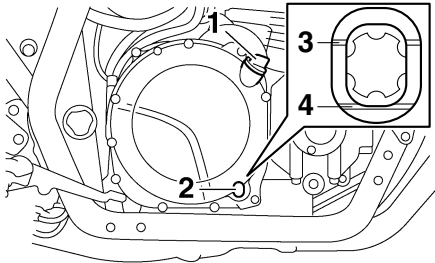

1. Engine oil filler cap
2. Engine oil level check window
3. Maximum level mark
4. Minimum level mark

4. If the engine oil is below the minimum level mark, add sufficient oil of the recommended type to raise it to the correct level.

To change the engine oil (with or without oil filter element replacement)

1. Place the vehicle on a level surface.
2. Start the engine, warm it up for several minutes, and then turn it off.
3. Place an oil pan under the engine to collect the used oil.

4. Remove the engine oil filler cap, the engine oil drain bolt and its gasket to drain the oil from the crankcase.

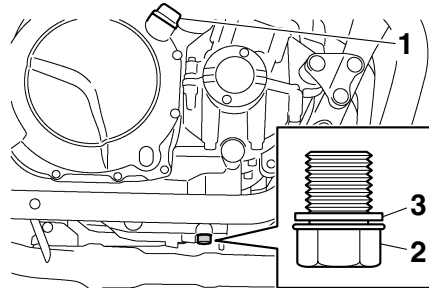

1. Engine oil filler cap
2. Engine oil drain bolt
3. Gasket

TIP Skip steps 5–15 if the oil filter element is not being replaced.

5. Remove panel C. (See page 7-8.)
6. Remove the oil filter element drain screw and its gasket to drain the oil from the oil filter element.
7. Remove the oil filter element cover by removing the oil filter element cover bolt.

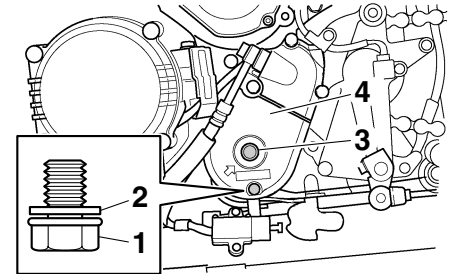

1. Oil filter element drain screw
2. Gasket
3. Oil filter element cover bolt
4. Oil filter element cover

8. Remove the oil filter element and O-rings.

TIP Take care not to lose the compression spring and washer.

PERIODIC MAINTENANCE AND ADJUSTMENT

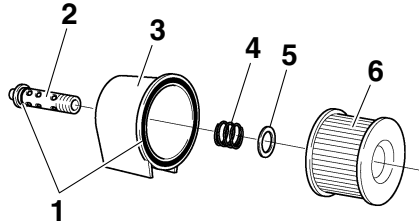

1. O-ring
2. Oil filter element cover bolt
3. Oil filter element cover
4. Compression spring
5. Washer
6. Oil filter element

9. Install new O-rings onto the element cover bolt and element cover.
10. Apply a thin coat of clean engine oil to the O-rings.
11. Insert the element cover bolt into the element cover.
12. Fit the spring, washer and a new oil filter element over the bolt.

TIP _____
Make sure the O-rings are properly seated.

13. Install the engine oil filter element cover (together with the spring, washer and oil filter element) by aligning the projection on the cover with the slot in the crankcase, and then tightening the bolt to the specified torque.

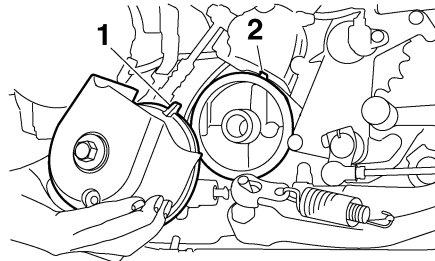

1. Projection
2. Slot

Tightening torque:

Oil filter element cover bolt:
15 Nm (1.5 m·kgf, 11 ft·lbf)

14. Install the oil filter element drain screw and its new gasket, and then tighten the screw to the specified torque.

Tightening torque:

Oil filter element drain screw:
7 Nm (0.7 m·kgf, 5.1 ft·lbf)

15. Install the panel.
16. Install the engine oil drain bolt and its new gasket, and then tighten the bolt to the specified torque.

Tightening torque:

Engine oil drain bolt:
43 Nm (4.3 m·kgf, 31 ft·lbf)

17. Refill with the specified amount of the recommended engine oil, and then install and tighten the oil filler cap.

Recommended engine oil:

See page 9-1.

Oil quantity:

Without oil filter element replacement:

2.80 L (2.96 US qt, 2.46 Imp.qt)

With oil filter element replacement:

3.15 L (3.33 US qt, 2.77 Imp.qt)

PERIODIC MAINTENANCE AND ADJUSTMENT

TIP _____

Be sure to wipe off spilled oil on any parts after the engine and exhaust system have cooled down.

ECA11620

NOTICE _____

- In order to prevent clutch slippage (since the engine oil also lubricates the clutch), do not mix any chemical additives. Do not use oils with a diesel specification of “CD” or oils of a higher quality than specified. In addition, do not use oils labeled “ENERGY CONSERVING II” or higher.
- Make sure that no foreign material enters the crankcase.

18. Start the engine, and then let it idle for several minutes while checking it for oil leakage. If oil is leaking, immediately turn the engine off and check for the cause.

TIP _____

After the engine is started, the engine oil level warning light should go off if the oil level is sufficient.

ECA10401

NOTICE _____

If the oil level warning light flickers or remains on even if the oil level is correct, immediately turn the engine off and have a Yamaha dealer check the vehicle.

19. Turn the engine off, and then check the oil level and correct it if necessary.

EAU43451

Replacing the air filter element and cleaning the check hose

The air filter element should be replaced at the intervals specified in the periodic maintenance and lubrication chart. Replace the air filter element more frequently if you are riding in unusually wet or dusty areas. In addition, the air filter check hose must be frequently checked and cleaned if necessary.

To replace the air filter element

1. Remove panel A. (See page 7-8.)
2. Remove the air filter case cover by removing the screws.

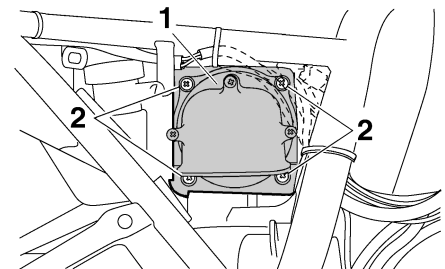

1. Air filter case cover
2. Screw

PERIODIC MAINTENANCE AND ADJUSTMENT

3. Pull the air filter element out.

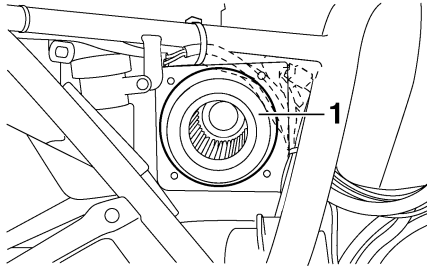

1. Air filter element

4. Insert a new air filter element into the air filter case. **NOTICE: Make sure that the air filter element is properly seated in the air filter case. The engine should never be operated without the air filter element installed, otherwise the piston(s) and/or cylinder(s) may become excessively worn.**

[ECA10481]

5. Install the air filter case cover by installing the screws.
6. Install the panel.

To clean the air filter check hose

1. Check the hose on the front of the air filter case for accumulated dirt or water.

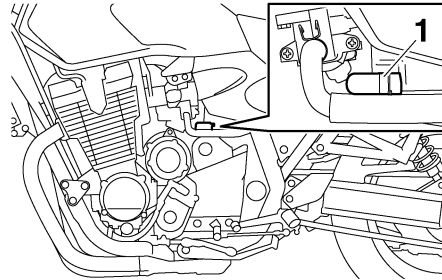

1. Air filter check hose

2. If dirt or water is visible, remove the hose, clean it, and then install it.

Checking the throttle grip free play

EAU21384

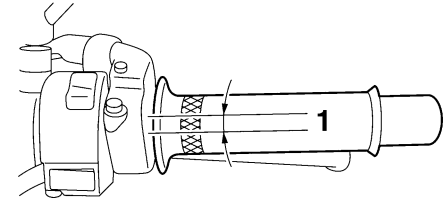

1. Throttle grip free play

The throttle grip free play should measure 3.0–5.0 mm (0.12–0.20 in) at the inner edge of the throttle grip. Periodically check the throttle grip free play and, if necessary, have a Yamaha dealer adjust it.

PERIODIC MAINTENANCE AND ADJUSTMENT

Valve clearance

EAU21401

The valve clearance changes with use, resulting in improper air-fuel mixture and/or engine noise. To prevent this from occurring, the valve clearance must be adjusted by a Yamaha dealer at the intervals specified in the periodic maintenance and lubrication chart.

Tires

EAU21783

To maximize the performance, durability, and safe operation of your motorcycle, note the following points regarding the specified tires.

Tire air pressure

The tire air pressure should be checked and, if necessary, adjusted before each ride.

EWA10503



WARNING

Operation of this vehicle with improper tire pressure may cause severe injury or death from loss of control.

- The tire air pressure must be checked and adjusted on cold tires (i.e., when the temperature of the tires equals the ambient temperature).
- The tire air pressure must be adjusted in accordance with the riding speed and with the total weight of rider, passenger, cargo, and accessories approved for this model.

Tire air pressure (measured on cold tires):

0–90 kg (0–198 lb):

Front:

250 kPa (2.50 kgf/cm², 36 psi)

Rear:

250 kPa (2.50 kgf/cm², 36 psi)

90–205 kg (198–452 lb):

Front:

250 kPa (2.50 kgf/cm², 36 psi)

Rear:

290 kPa (2.90 kgf/cm², 42 psi)

High-speed riding:

Front:

250 kPa (2.50 kgf/cm², 36 psi)

Rear:

290 kPa (2.90 kgf/cm², 42 psi)

Maximum load*:

205 kg (452 lb)

* Total weight of rider, passenger, cargo and accessories

EWA10511



WARNING

Never overload your vehicle. Operation of an overloaded vehicle could cause an accident.

PERIODIC MAINTENANCE AND ADJUSTMENT

Tire inspection

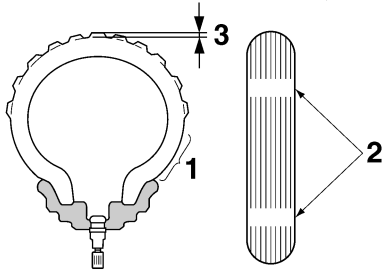

1. Tire sidewall
2. Tire wear indicator
3. Tire tread depth

Always check the tires before operating the motorcycle. If a tire tread shows crosswise lines (minimum tread depth), if the tire has a nail or glass fragments in it, or if the sidewall is cracked, contact a Yamaha dealer immediately and have the tire replaced.

EWA10471

WARNING

- Have a Yamaha dealer replace excessively worn tires. Besides being illegal, operating the vehicle with excessively worn tires decreases riding stability and can lead to loss of control.

- The replacement of all wheel and brake-related parts, including the tires, should be left to a Yamaha dealer, who has the necessary professional knowledge and experience to do so.
- Ride at moderate speeds after changing a tire since the tire surface must first be “broken in” for it to develop its optimal characteristics.

Minimum tire tread depth (front and rear):

1.0 mm (0.04 in)

TIP

The tire tread depth limits may differ from country to country. Always comply with the local regulations.

Tire information

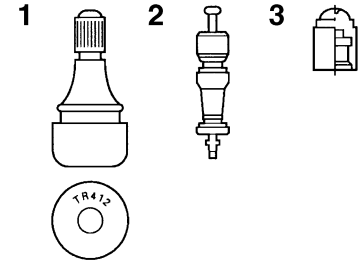

1. Tire air valve
2. Tire air valve core
3. Tire air valve cap with seal

This motorcycle is equipped with cast wheels and tubeless tires with valves.

EWA10481

WARNING

- The front and rear tires should be of the same make and design, otherwise the handling characteristics of the motorcycle may be different, which could lead to an accident.
- Always make sure that the valve caps are securely installed to prevent air pressure leakage.

PERIODIC MAINTENANCE AND ADJUSTMENT

- Use only the tire valves and valve cores listed below to avoid tire deflation during a high-speed ride.

After extensive tests, only the tires listed below have been approved for this model by Yamaha Motor Co., Ltd.

Front tire:

Size:

120/70 ZR17M/C (58W)

Manufacturer/model:

DUNLOP/D252F L

Rear tire:

Size:

180/55 ZR17M/C (73W)

Manufacturer/model:

DUNLOP/D252 L

FRONT and REAR:

Tire air valve:

TR412

Valve core:

#9100 (original)

EWA10600



WARNING

This motorcycle is fitted with super-high-speed tires. Note the following points in order to make the most efficient use of these tires.

- Use only the specified replacement tires. Other tires may run the danger of bursting at super high speeds.
- Brand-new tires can have a relatively poor grip on certain road surfaces until they have been “broken in”. Therefore, it is advisable before doing any high-speed riding to ride conservatively for approximately 100 km (60 mi) after installing a new tire.
- The tires must be warmed up before a high-speed run.
- Always adjust the tire air pressure according to the operating conditions.

EAU21962

Cast wheels

To maximize the performance, durability, and safe operation of your vehicle, note the following points regarding the specified wheels.

- The wheel rims should be checked for cracks, bends, warpage or other damage before each ride. If any damage is found, have a Yamaha dealer replace the wheel. Do not attempt even the smallest repair to the wheel. A deformed or cracked wheel must be replaced.
- The wheel should be balanced whenever either the tire or wheel has been changed or replaced. An unbalanced wheel can result in poor performance, adverse handling characteristics, and a shortened tire life.

PERIODIC MAINTENANCE AND ADJUSTMENT

Clutch lever

EAU22073

Since this model is equipped with a hydraulic clutch, adjusting the clutch lever free play is not needed. However, it is necessary to check the clutch fluid level and check the hydraulic system for leakage before each ride. (See page 7-20.) If the clutch lever free play does become excessive, and shifting becomes rough or clutch slippage occurs, causing poor acceleration, there may be air in the clutch system. If there is air in the hydraulic system, have a Yamaha dealer bleed the system before operating the motorcycle.

Checking the brake lever free play

EAU37913

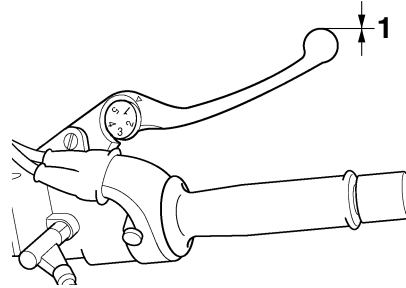

1. No brake lever free play

There should be no free play at the brake lever end. If there is free play, have a Yamaha dealer inspect the brake system.

EWA14211

WARNING

A soft or spongy feeling in the brake lever can indicate the presence of air in the hydraulic system. If there is air in the hydraulic system, have a Yamaha dealer bleed the system before operating the vehicle. Air in the hydraulic system will diminish the

braking performance, which may result in loss of control and an accident.

PERIODIC MAINTENANCE AND ADJUSTMENT

EAU22293

3. Install the panel.

Brake light switches

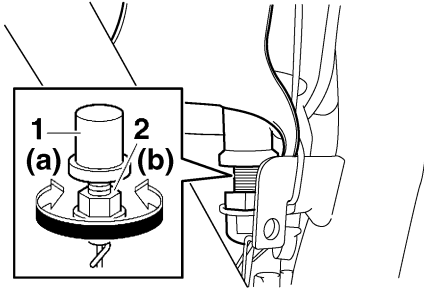

1. Rear brake light switch
2. Rear brake light switch adjusting nut

The brake light, which is activated by the brake pedal and brake lever, should come on just before braking takes effect. If necessary, adjust the rear brake light switch as follows, but the front brake light switch should be adjusted by a Yamaha dealer.

1. Remove panel A. (See page 7-8.)
2. Turn the adjusting nut while holding the rear brake light switch in place. To make the brake light come on earlier, turn the adjusting nut in direction (a). To make the brake light come on later, turn the adjusting nut in direction (b).

EAU22321

Checking the front and rear brake pads

Front brake

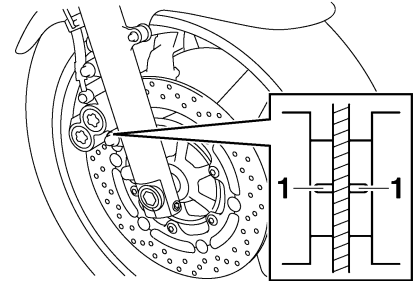

1. Brake pad wear indicator groove

Rear brake

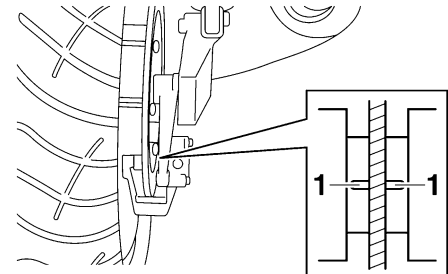

1. Brake pad wear indicator groove

PERIODIC MAINTENANCE AND ADJUSTMENT

The front and rear brake pads must be checked for wear at the intervals specified in the periodic maintenance and lubrication chart. Each brake pad is provided with a wear indicator groove, which allows you to check the brake pad wear without having to disassemble the brake. To check the brake pad wear, check the wear indicator grooves. If a brake pad has worn to the point that the wear indicator groove has almost disappeared, have a Yamaha dealer replace the brake pads as a set.

Checking the brake and clutch fluid levels

EAU22680

Front brake

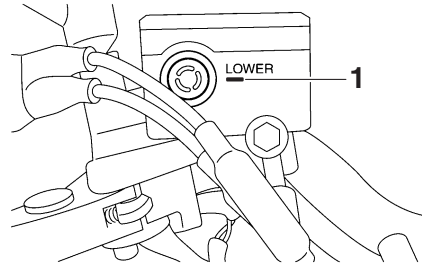

1. Minimum level mark

Rear brake

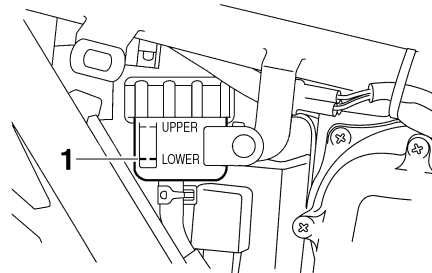

1. Minimum level mark

Clutch

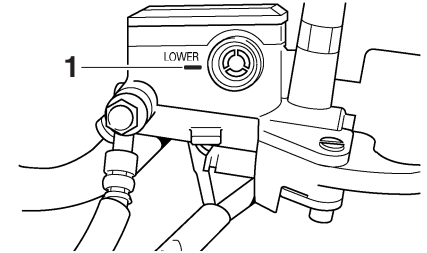

1. Minimum level mark

Insufficient brake fluid may allow air to enter the brake or clutch systems, possibly causing them to become ineffective.

Before riding, check that the brake fluid is above the minimum level mark and replenish if necessary. A low brake fluid level may indicate worn brake pads and/or brake system leakage. If the brake level is low, be sure to check the brake pads for wear and the brake system for leakage.

TIP

The rear brake fluid reservoir is located behind panel A. (See page 7-8.)

Observe these precautions:

PERIODIC MAINTENANCE AND ADJUSTMENT

EAU22751

- When checking the fluid level, make sure that the top of the brake or clutch fluid reservoir is level.
- Use only the recommended quality brake fluid, otherwise the rubber seals may deteriorate, causing leakage and poor braking or clutch performance.

Recommended brake and clutch fluid:

DOT 4 brake fluid

- Refill with the same type of brake fluid. Mixing fluids may result in a harmful chemical reaction and lead to poor braking or clutch performance.
- The brake or clutch fluid reservoir diaphragm will lose its shape from the negative pressure if the fluid level goes down too far. Be sure to return the diaphragm to its original shape before installing it into the brake or clutch fluid reservoir.
- Be careful that water does not enter the brake or clutch fluid reservoir when refilling. Water will

significantly lower the boiling point of the fluid and may result in vapor lock.

- Brake fluid may deteriorate painted surfaces or plastic parts. Always clean up spilled fluid immediately.
- As the brake pads wear, it is normal for the brake fluid level to gradually go down. However, if the brake fluid level goes down suddenly, have a Yamaha dealer check the cause.

Changing the brake and clutch fluids

Have a Yamaha dealer change the brake and clutch fluids at the intervals specified in the TIP after the periodic maintenance and lubrication chart. In addition, have the oil seals of the brake and clutch master cylinders and calipers as well as the brake and clutch hoses replaced at the intervals listed below or whenever they are damaged or leaking.

- Oil seals: Replace every two years.
- Brake and clutch hoses: Replace every four years.

PERIODIC MAINTENANCE AND ADJUSTMENT

Drive chain slack

EAU22760

The drive chain slack should be checked before each ride and adjusted if necessary.

To check the drive chain slack

EAU22793

1. Place the motorcycle on the centerstand.
2. Shift the transmission into the neutral position.
3. Spin the rear wheel several times to locate the tightest portion of the drive chain.
4. Measure the drive chain slack as shown.

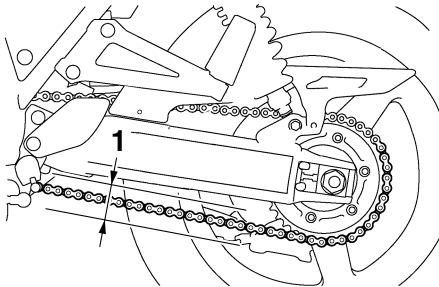

1. Drive chain slack

Drive chain slack:

20.0–30.0 mm (0.79–1.18 in)

5. If the drive chain slack is incorrect, adjust it as follows.

To adjust the drive chain slack

EAU49311

1. Take the motorcycle off the centerstand, and then put the sidestand down.
2. Loosen the axle nut and the locknut on each side of the swingarm.
3. Place the motorcycle on the centerstand.
4. To tighten the drive chain, turn the drive chain slack adjusting bolt on each side of the swingarm in direction (a). To loosen the drive chain, turn the adjusting bolt on each side of the swingarm in direction (b), and then push the rear wheel forward. **NOTICE: Improper drive chain slack will overload the engine as well as other vital parts of the motorcycle and can lead to chain slippage or breakage.**

To prevent this from occurring, keep the drive chain slack within the specified limits. [ECA10571]

TIP

Using the alignment marks on each side of the swingarm, make sure that both drive chain pullers are in the same position for proper wheel alignment.

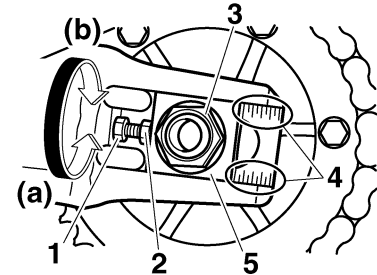

1. Locknut
2. Drive chain slack adjusting bolt
3. Axle nut
4. Alignment marks
5. Drive chain puller

5. Take the motorcycle off the centerstand, and then put the sidestand down.
6. Tighten the axle nut, then the locknuts to the specified torques.

PERIODIC MAINTENANCE AND ADJUSTMENT

Tightening torques:

Axle nut:

150 Nm (15 m·kgf, 108 ft·lbf)

Locknut:

16 Nm (1.6 m·kgf, 12 ft·lbf)

EAU23025

Cleaning and lubricating the drive chain

The drive chain must be cleaned and lubricated at the intervals specified in the periodic maintenance and lubrication chart, otherwise it will quickly wear out, especially when riding in dusty or wet areas. Service the drive chain as follows.

ECA10583

NOTICE

The drive chain must be lubricated after washing the motorcycle, riding in the rain or riding in wet areas.

1. Clean the drive chain with kerosene and a small soft brush.
NOTICE: To prevent damaging the O-rings, do not clean the drive chain with steam cleaners, high-pressure washers or inappropriate solvents. [ECA11121]
2. Wipe the drive chain dry.
3. Thoroughly lubricate the drive chain with a special O-ring chain lubricant. **NOTICE: Do not use engine oil or any other lubricants for the drive chain, as they**

may contain substances that could damage the O-rings.

[ECA11111]

PERIODIC MAINTENANCE AND ADJUSTMENT

Checking and lubricating the cables

EAU23095

The operation of all control cables and the condition of the cables should be checked before each ride, and the cables and cable ends should be lubricated if necessary. If a cable is damaged or does not move smoothly, have a Yamaha dealer check or replace it. **WARNING! Damage to the outer housing of cables may result in internal rusting and cause interference with cable movement. Replace damaged cables as soon as possible to prevent unsafe conditions.**

[EWA10711]

Recommended lubricant:

Yamaha Chain and Cable Lube or engine oil

Checking and lubricating the throttle grip and cable

EAU23114

The operation of the throttle grip should be checked before each ride. In addition, the cable should be lubricated by a Yamaha dealer at the intervals specified in the periodic maintenance chart. The throttle cable is equipped with a rubber cover. Make sure that the cover is securely installed. Even though the cover is installed correctly, it does not completely protect the cable from water entry. Therefore, use care not to pour water directly onto the cover or cable when washing the vehicle. If the cable or cover becomes dirty, wipe clean with a moist cloth.

Checking and lubricating the brake and shift pedals

EAU44272

Brake pedal

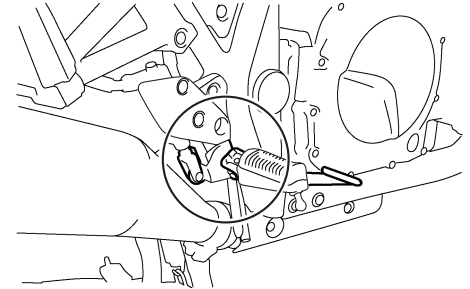

Shift pedal

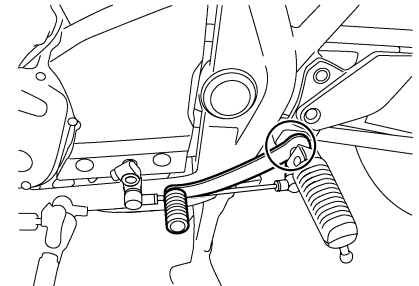

The operation of the brake and shift pedals should be checked before each ride, and the pedal pivots should be lubricated if necessary.

PERIODIC MAINTENANCE AND ADJUSTMENT

Recommended lubricant:
Lithium-soap-based grease

**Checking and lubricating the
brake and clutch levers**

EAU43600

Recommended lubricant:
Silicone grease

Brake lever

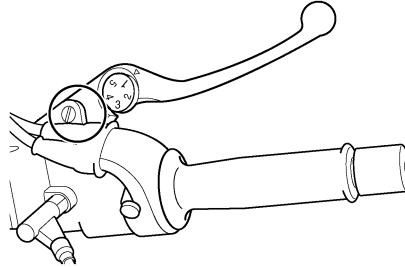

Clutch lever

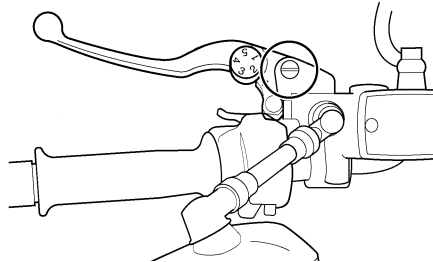

The operation of the brake and clutch levers should be checked before each ride, and the lever pivots should be lubricated if necessary.

PERIODIC MAINTENANCE AND ADJUSTMENT

Checking and lubricating the centerstand and sidestand

EAU23213

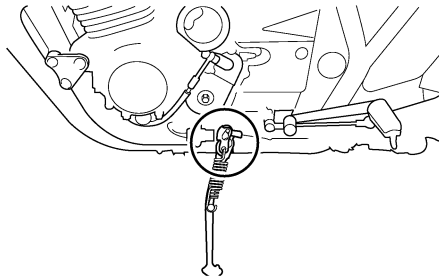
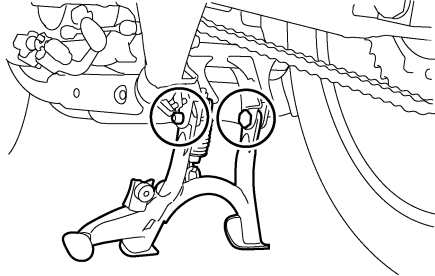

The operation of the centerstand and sidestand should be checked before each ride, and the pivots and metal-to-metal contact surfaces should be lubricated if necessary.

! WARNING

EWA10741

If the centerstand or sidestand does not move up and down smoothly, have a Yamaha dealer check or repair it. Otherwise, the centerstand or sidestand could contact the ground and distract the operator, resulting in a possible loss of control.

Recommended lubricant:
Lithium-soap-based grease

EAUM1651

Lubricating the swingarm pivots

The swingarm pivots must be lubricated by a Yamaha dealer at the intervals specified in the periodic maintenance and lubrication chart.

Recommended lubricant:
Lithium-soap-based grease

PERIODIC MAINTENANCE AND ADJUSTMENT

EAU23272

Checking the front fork

The condition and operation of the front fork must be checked as follows at the intervals specified in the periodic maintenance and lubrication chart.

To check the condition

Check the inner tubes for scratches, damage and excessive oil leakage.

To check the operation

1. Place the vehicle on a level surface and hold it in an upright position. **WARNING! To avoid injury, securely support the vehicle so there is no danger of it falling over.** [EWA10751]
2. While applying the front brake, push down hard on the handlebars several times to check if the front fork compresses and rebounds smoothly.

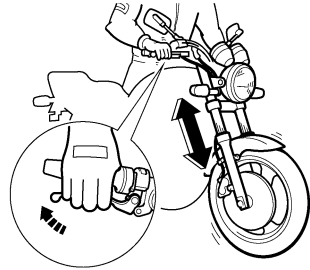

ECA10590

NOTICE

If any damage is found or the front fork does not operate smoothly, have a Yamaha dealer check or repair it.

EAU45511

Checking the steering

Worn or loose steering bearings may cause danger. Therefore, the operation of the steering must be checked as follows at the intervals specified in the periodic maintenance and lubrication chart.

1. Place the vehicle on the centerstand. **WARNING! To avoid injury, securely support the vehicle so there is no danger of it falling over.** [EWA10751]
2. Hold the lower ends of the front fork legs and try to move them forward and backward. If any free play can be felt, have a Yamaha dealer check or repair the steering.

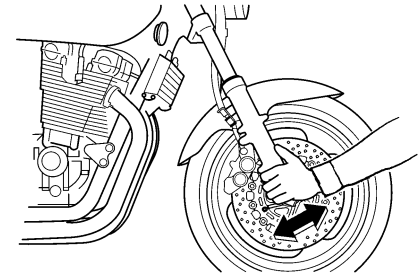

PERIODIC MAINTENANCE AND ADJUSTMENT

Checking the wheel bearings

EAU23291

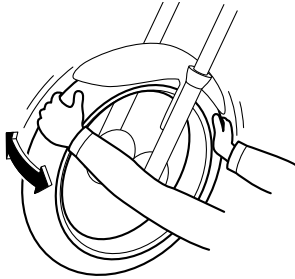

The front and rear wheel bearings must be checked at the intervals specified in the periodic maintenance and lubrication chart. If there is play in the wheel hub or if the wheel does not turn smoothly, have a Yamaha dealer check the wheel bearings.

Battery

EAU50290

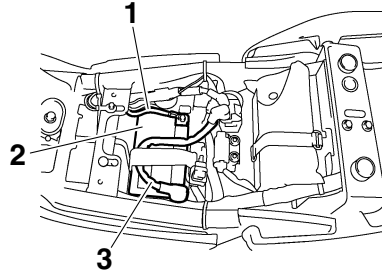

1. Negative battery lead (black)
2. Battery
3. Positive battery lead (red)

The battery is located under the seat. (See page 4-15.)

This model is equipped with a VRLA (Valve Regulated Lead Acid) battery. There is no need to check the electrolyte or to add distilled water. However, the battery lead connections need to be checked and, if necessary, tightened.

EWA10760

⚠ WARNING

- **Electrolyte is poisonous and dangerous since it contains sulfuric acid, which causes severe burns. Avoid any contact with**

skin, eyes or clothing and always shield your eyes when working near batteries. In case of contact, administer the following FIRST AID.

- **EXTERNAL:** Flush with plenty of water.
- **INTERNAL:** Drink large quantities of water or milk and immediately call a physician.
- **EYES:** Flush with water for 15 minutes and seek prompt medical attention.
- **Batteries produce explosive hydrogen gas. Therefore, keep sparks, flames, cigarettes, etc., away from the battery and provide sufficient ventilation when charging it in an enclosed space.**
- **KEEP THIS AND ALL BATTERIES OUT OF THE REACH OF CHILDREN.**

To charge the battery

Have a Yamaha dealer charge the battery as soon as possible if it seems to have discharged. Keep in mind that the

PERIODIC MAINTENANCE AND ADJUSTMENT

battery tends to discharge more quickly if the vehicle is equipped with optional electrical accessories.

ECA16521

NOTICE

To charge a VRLA (Valve Regulated Lead Acid) battery, a special (constant-voltage) battery charger is required. Using a conventional battery charger will damage the battery.

To store the battery

1. If the vehicle will not be used for more than one month, remove the battery, fully charge it, and then place it in a cool, dry place. **NOTICE: When removing the battery, be sure the key is turned to “OFF”, then disconnect the negative lead before disconnecting the positive lead.**

[ECA16302]

2. If the battery will be stored for more than two months, check it at least once a month and fully charge it if necessary.
3. Fully charge the battery before installation. **NOTICE: When installing the battery, be sure the key**

is turned to “OFF”, then connect the positive lead before connecting the negative lead.

[ECA16840]

4. After installation, make sure that the battery leads are properly connected to the battery terminals.

ECA16530

NOTICE

Always keep the battery charged. Storing a discharged battery can cause permanent battery damage.

Replacing the fuses

The main fuse is located under the seat. (See page 4-15.)

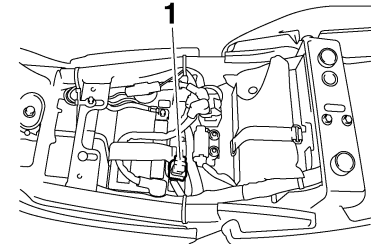

1. Main fuse

The fuse box, which contains the fuses for the individual circuits, is located behind panel B. (See page 7-8.)

PERIODIC MAINTENANCE AND ADJUSTMENT

EAU23797

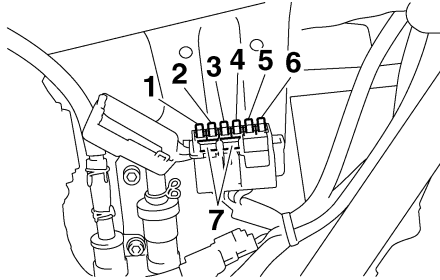

1. Headlight fuse
2. Signaling system fuse
3. Ignition fuse
4. Taillight fuse
5. Fuel injection system fuse
6. Backup fuse (for clock and immobilizer system)
7. Spare fuse

If a fuse is blown, replace it as follows.

1. Turn the key to "OFF" and turn off the electrical circuit in question.
2. Remove the blown fuse, and then install a new fuse of the specified amperage. **WARNING! Do not use a fuse of a higher amperage rating than recommended to avoid causing extensive damage to the electrical system and possibly a fire.** [EWA15131]

Specified fuses:

- Main fuse:
50.0 A
 - Headlight fuse:
15.0 A
 - Taillight fuse:
7.5 A
 - Signaling system fuse:
7.5 A
 - Ignition fuse:
15.0 A
 - Fuel injection system fuse:
15.0 A
 - Backup fuse:
7.5 A
3. Turn the key to "ON" and turn on the electrical circuit in question to check if the device operates.
 4. If the fuse immediately blows again, have a Yamaha dealer check the electrical system.

Replacing the headlight bulb

This model is equipped with a halogen bulb headlight. If the headlight bulb burns out, replace it as follows.

ECA10650

NOTICE

Take care not to damage the following parts:

- **Headlight bulb**
Do not touch the glass part of the headlight bulb to keep it free from oil, otherwise the transparency of the glass, the luminosity of the bulb, and the bulb life will be adversely affected. Thoroughly clean off any dirt and fingerprints on the headlight bulb using a cloth moistened with alcohol or thinner.
- **Headlight lens**
Do not affix any type of tinted film or stickers to the headlight lens.
Do not use a headlight bulb of a wattage higher than specified.

PERIODIC MAINTENANCE AND ADJUSTMENT

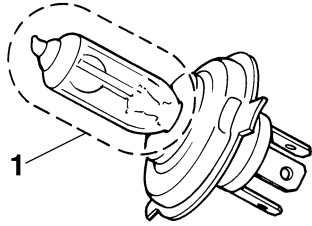

1. Do not touch the glass part of the bulb.

1. Remove the headlight unit by removing the screws.

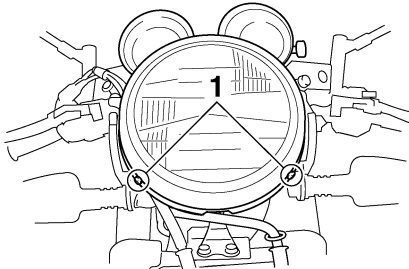

1. Screw

2. Disconnect the headlight coupler, and then remove the bulb cover.

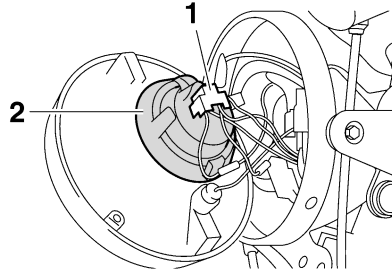

1. Headlight coupler
2. Headlight bulb cover

3. Unhook the headlight bulb holder, and then remove the burnt-out bulb.

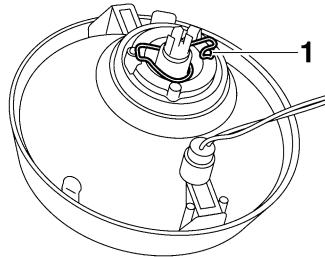

1. Headlight bulb holder

4. Place a new headlight bulb into position, and then secure it with the bulb holder.

5. Install the headlight bulb cover, and then connect the coupler.
6. Install the headlight unit by installing the screws.
7. Have a Yamaha dealer adjust the headlight beam if necessary.

PERIODIC MAINTENANCE AND ADJUSTMENT

Tail/brake light

This model is equipped with an LED-type tail/brake light.

If the tail/brake light does not come on, have a Yamaha dealer check it.

EAU24181

Replacing a turn signal light bulb

1. Remove the turn signal light lens by removing the screw.

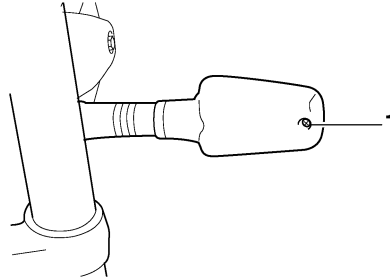

1. Screw

2. Remove the burnt-out bulb by pushing it in and turning it counter-clockwise.

EAU24204

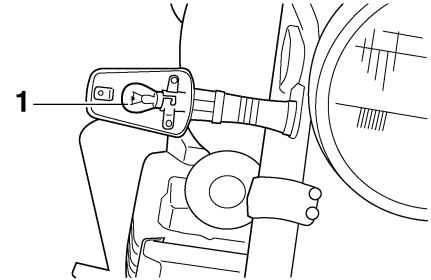

1. Turn signal light bulb

3. Insert a new bulb into the socket, push it in, and then turn it clockwise until it stops.
4. Install the lens by installing the screw. **NOTICE: Do not over-tighten the screw, otherwise the lens may break.** [ECA11191]

PERIODIC MAINTENANCE AND ADJUSTMENT

EAU24313

Replacing the license plate light bulb

1. Remove the license plate light unit by removing the screws.

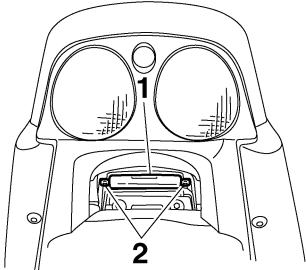

1. License plate light unit
2. Screw

2. Remove the license plate light bulb socket (together with the bulb) by pulling it out.

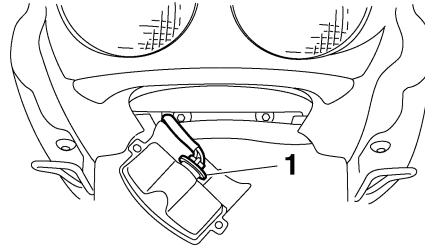

1. License plate light bulb socket
3. Remove the burnt-out bulb by pulling it out.
4. Insert a new bulb into the socket.
5. Install the socket (together with the bulb) by pushing it in.
6. Install the license plate light unit by installing the screws.

EAU33544

Replacing the auxiliary light bulb

If the auxiliary light bulb burns out, replace it as follows.

1. Remove the headlight unit by removing the screws.

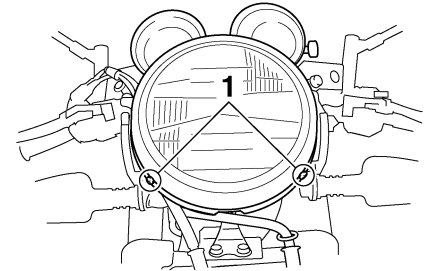

1. Screw

2. Remove the auxiliary light bulb socket (together with the bulb) by pulling it out.

PERIODIC MAINTENANCE AND ADJUSTMENT

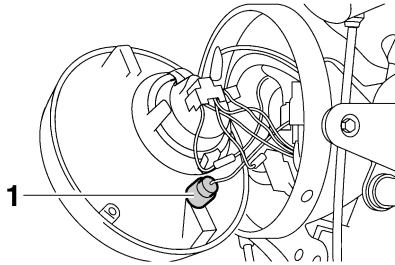

1. Auxiliary light bulb socket
3. Remove the burnt-out bulb by pushing it in and turning it counter-clockwise.
4. Insert a new bulb into the socket, push it in, and then turn it clockwise until it stops.
5. Install the socket (together with the bulb) by pushing it in.
6. Install the headlight unit by installing the screws.

Front wheel

EAU24360

To remove the front wheel

EAU33682

EWA10821



To avoid injury, securely support the vehicle so there is no danger of it falling over.

1. Place the motorcycle on the centerstand.
2. Loosen the front wheel axle pinch bolt, then the wheel axle and the brake caliper bolts.

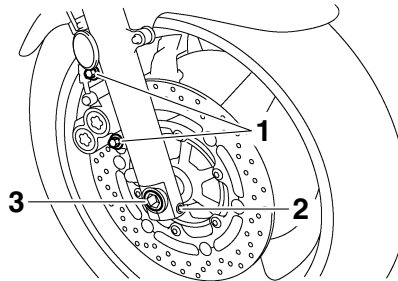

1. Brake caliper bolt
2. Front wheel axle pinch bolt
3. Wheel axle

3. Remove the brake hose holder and reflector on each side by removing the bolt.
4. Remove the brake caliper on each side by removing the bolts. **NOTICE: Do not apply the brake after the brake calipers have been removed, otherwise the brake pads will be forced shut.**

[ECA11051]

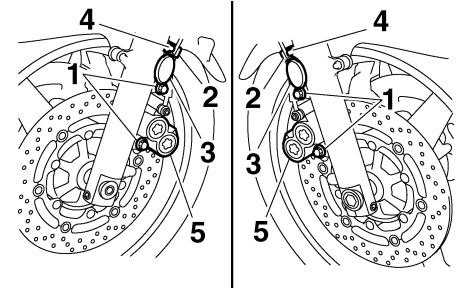

1. Brake caliper bolt
2. Brake hose holder
3. Reflector
4. Bolt
5. Brake caliper

5. Pull the wheel axle out, and then remove the wheel.

PERIODIC MAINTENANCE AND ADJUSTMENT

To install the front wheel

EAU33771

1. Lift the wheel up between the fork legs.
2. Insert the wheel axle.
3. Install the brake calipers by installing the bolts.

TIP

Make sure that there is enough space between the brake pads before installing the brake calipers onto the brake discs.

4. Install the brake hose holders and reflectors by installing the bolts.
5. Lower the front wheel so that it is on the ground, and then put the sidestand down.
6. Tighten the wheel axle, the front wheel axle pinch bolt and the brake caliper bolts to the specified torques.

Tightening torques:

Wheel axle:

72 Nm (7.2 m·kgf, 52 ft·lbf)

Front wheel axle pinch bolt:

20 Nm (2.0 m·kgf, 14 ft·lbf)

Brake caliper bolt:

40 Nm (4.0 m·kgf, 29 ft·lbf)

7. Push down hard on the handlebar several times to check for proper fork operation.

Rear wheel

EAU25080

To remove the rear wheel

EAU25162

EWA10821

⚠ WARNING

To avoid injury, securely support the vehicle so there is no danger of it falling over.

1. Loosen the axle nut and the brake caliper bolts.

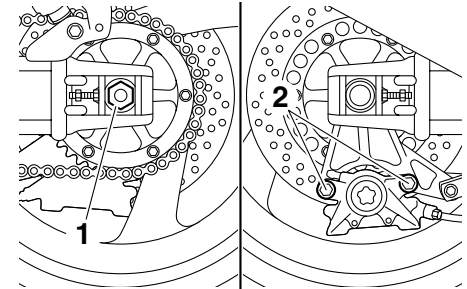

1. Axle nut

2. Brake caliper bolt

2. Disconnect the brake torque rod from the brake caliper bracket by removing the nut and the bolt.

PERIODIC MAINTENANCE AND ADJUSTMENT

EAU25843

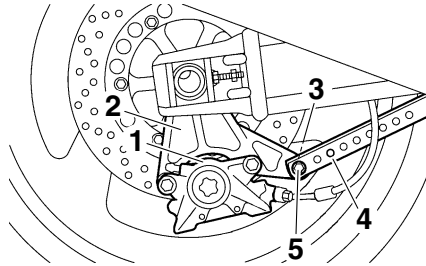

1. Brake caliper
2. Brake caliper bracket
3. Bolt
4. Brake torque rod
5. Nut

3. Place the motorcycle on the centerstand.
4. Remove the axle nut and the brake caliper by removing the bolts. **NOTICE: Do not apply the brake after the brake caliper has been removed, otherwise the brake pads will be forced shut.** [ECA11301]
5. Loosen the locknuts, and then turn the drive chain slack adjusting bolt on each side of the swingarm fully in direction (a).

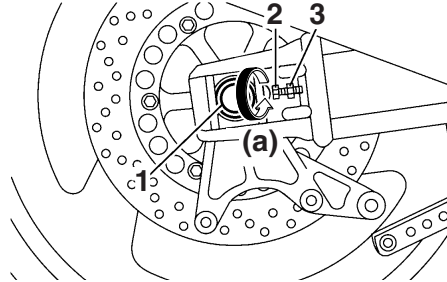

1. Wheel axle
2. Drive chain slack adjusting bolt
3. Locknut

6. Push the wheel forward, and then remove the drive chain from the rear sprocket.

TIP

The drive chain does not need to be disassembled in order to remove and install the rear wheel.

7. While supporting the wheel and the brake caliper bracket, pull the wheel axle out.
8. Remove the brake caliper bracket and the wheel.

To install the rear wheel

1. Place the wheel and the brake caliper bracket in the original position.
2. Insert the wheel axle through the brake caliper bracket and wheel from the right-hand side, and then install the axle nut.
3. Install the drive chain onto the rear sprocket.
4. Connect the brake torque rod to the brake caliper bracket by installing the bolt and the nut.
5. Install the brake caliper by installing the bolts.

TIP

Make sure that there is enough space between the brake pads before installing the brake caliper onto the brake disc.

6. Adjust the drive chain slack. (See page 7-22.)
7. Take the motorcycle off the centerstand, and then put the sidestand down.
8. Tighten the axle nut, brake caliper bolts and brake torque rod nut to the specified torques.

PERIODIC MAINTENANCE AND ADJUSTMENT

Tightening torques:

Axle nut:

150 Nm (15 m·kgf, 108 ft·lbf)

Brake caliper bolt:

40 Nm (4.0 m·kgf, 29 ft·lbf)

Brake torque rod nut:

23 Nm (2.3 m·kgf, 17 ft·lbf)

EAU25851

Troubleshooting

Although Yamaha motorcycles receive a thorough inspection before shipment from the factory, trouble may occur during operation. Any problem in the fuel, compression, or ignition systems, for example, can cause poor starting and loss of power.

The following troubleshooting chart represents a quick and easy procedure for checking these vital systems yourself. However, should your motorcycle require any repair, take it to a Yamaha dealer, whose skilled technicians have the necessary tools, experience, and know-how to service the motorcycle properly.

Use only genuine Yamaha replacement parts. Imitation parts may look like Yamaha parts, but they are often inferior, have a shorter service life and can lead to expensive repair bills.

EWA15141



When checking the fuel system, do not smoke, and make sure there are no open flames or sparks in the area, including pilot lights from water

heaters or furnaces. Gasoline or gasoline vapors can ignite or explode, causing severe injury or property damage.

PERIODIC MAINTENANCE AND ADJUSTMENT

EAU42602

Troubleshooting chart

1. Fuel

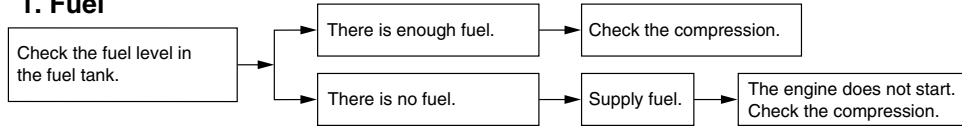

2. Compression

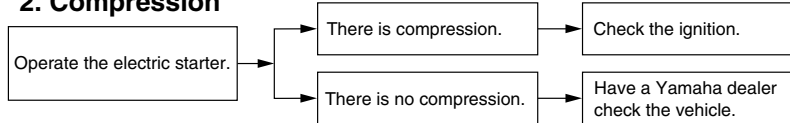

3. Ignition

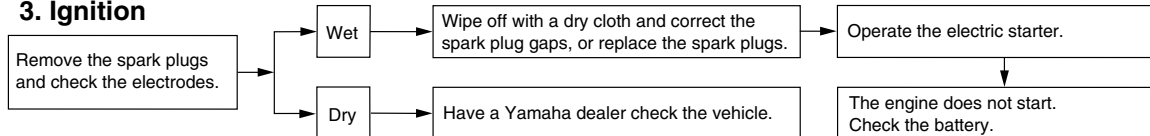

4. Battery

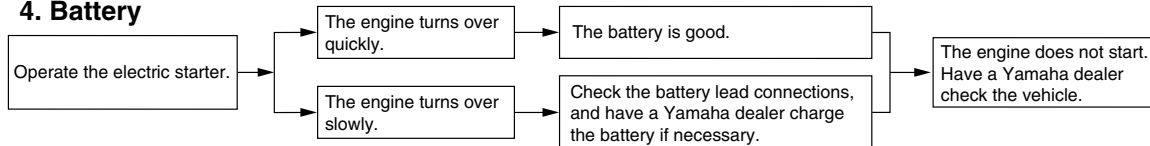

MOTORCYCLE CARE AND STORAGE

Matte color caution

EAU37833

ECA15192

NOTICE

Some models are equipped with matte colored finished parts. Be sure to consult a Yamaha dealer for advice on what products to use before cleaning the vehicle. Using a brush, harsh chemical products or cleaning compounds when cleaning these parts will scratch or damage their surface. Wax also should not be applied to any matte colored finished parts.

Care

EAU26014

While the open design of a motorcycle reveals the attractiveness of the technology, it also makes it more vulnerable. Rust and corrosion can develop even if high-quality components are used. A rusty exhaust pipe may go unnoticed on a car, however, it detracts from the overall appearance of a motorcycle. Frequent and proper care does not only comply with the terms of the warranty, but it will also keep your motorcycle looking good, extend its life and optimize its performance.

Before cleaning

1. Cover the muffler outlet with a plastic bag after the engine has cooled down.
2. Make sure that all caps and covers as well as all electrical couplers and connectors, including the spark plug caps, are tightly installed.
3. Remove extremely stubborn dirt, like oil burnt onto the crankcase, with a degreasing agent and a brush, but never apply such prod-

ucts onto seals, gaskets, sprockets, the drive chain and wheel axles. Always rinse the dirt and degreaser off with water.

Cleaning

ECA10772

NOTICE

- **Avoid using strong acidic wheel cleaners, especially on spoked wheels. If such products are used on hard-to-remove dirt, do not leave the cleaner on the affected area any longer than instructed. Also, thoroughly rinse the area off with water, immediately dry it, and then apply a corrosion protection spray.**
- **Improper cleaning can damage plastic parts (such as cowlings, panels, windshields, headlight lenses, meter lenses, etc.) and the mufflers. Use only a soft, clean cloth or sponge with water to clean plastic. However, if the plastic parts cannot be thoroughly cleaned with water, diluted mild detergent with water may be used. Be sure to rinse**

MOTORCYCLE CARE AND STORAGE

off any detergent residue using plenty of water, as it is harmful to plastic parts.

- Do not use any harsh chemical products on plastic parts. Be sure to avoid using cloths or sponges which have been in contact with strong or abrasive cleaning products, solvent or thinner, fuel (gasoline), rust removers or inhibitors, brake fluid, antifreeze or electrolyte.
- Do not use high-pressure washers or steam-jet cleaners since they cause water seepage and deterioration in the following areas: seals (of wheel and swing-arm bearings, fork and brakes), electric components (couplers, connectors, instruments, switches and lights), breather hoses and vents.
- For motorcycles equipped with a windshield: Do not use strong cleaners or hard sponges as they will cause dulling or scratching. Some cleaning compounds for plastic may leave scratches on the windshield.

Test the product on a small hidden part of the windshield to make sure that it does not leave any marks. If the windshield is scratched, use a quality plastic polishing compound after washing.

After normal use

Remove dirt with warm water, a mild detergent, and a soft, clean sponge, and then rinse thoroughly with clean water. Use a toothbrush or bottlebrush for hard-to-reach areas. Stubborn dirt and insects will come off more easily if the area is covered with a wet cloth for a few minutes before cleaning.

After riding in the rain, near the sea or on salt-sprayed roads

Since sea salt or salt sprayed on roads during winter are extremely corrosive in combination with water, carry out the following steps after each ride in the rain, near the sea or on salt-sprayed roads.

TIP

Salt sprayed on roads in the winter may remain well into spring.

1. Clean the motorcycle with cold water and a mild detergent, after the engine has cooled down.
NOTICE: Do not use warm water since it increases the corrosive action of the salt. [ECA10791]
2. Apply a corrosion protection spray on all metal, including chrome- and nickel-plated, surfaces to prevent corrosion.

After cleaning

1. Dry the motorcycle with a chamois or an absorbing cloth.
2. Immediately dry the drive chain and lubricate it to prevent it from rusting.
3. Use a chrome polish to shine chrome, aluminum and stainless-steel parts, including the exhaust system. (Even the thermally induced discoloring of stainless-steel exhaust systems can be removed through polishing.)

MOTORCYCLE CARE AND STORAGE

ECA10800

4. To prevent corrosion, it is recommended to apply a corrosion protection spray on all metal, including chrome- and nickel-plated, surfaces.
5. Use spray oil as a universal cleaner to remove any remaining dirt.
6. Touch up minor paint damage caused by stones, etc.
7. Wax all painted surfaces.
8. Let the motorcycle dry completely before storing or covering it.

EWA11131

WARNING

Contaminants on the brakes or tires can cause loss of control.

- **Make sure that there is no oil or wax on the brakes or tires.**
- **If necessary, clean the brake discs and brake linings with a regular brake disc cleaner or acetone, and wash the tires with warm water and a mild detergent. Before riding at higher speeds, test the motorcycle's braking performance and cornering behavior.**

NOTICE

- **Apply spray oil and wax sparingly and make sure to wipe off any excess.**
- **Never apply oil or wax to any rubber and plastic parts, but treat them with a suitable care product.**
- **Avoid using abrasive polishing compounds as they will wear away the paint.**

TIP

- Consult a Yamaha dealer for advice on what products to use.
- Washing, rainy weather or humid climates can cause the headlight lens to fog. Turning the headlight on for a short period of time will help remove the moisture from the lens.

EAU26182

Storage

Short-term

Always store your motorcycle in a cool, dry place and, if necessary, protect it against dust with a porous cover. Be sure the engine and the exhaust system are cool before covering the motorcycle.

ECA10810

NOTICE

- **Storing the motorcycle in a poorly ventilated room or covering it with a tarp, while it is still wet, will allow water and humidity to seep in and cause rust.**
- **To prevent corrosion, avoid damp cellars, stables (because of the presence of ammonia) and areas where strong chemicals are stored.**

Long-term

Before storing your motorcycle for several months:

1. Follow all the instructions in the "Care" section of this chapter.

MOTORCYCLE CARE AND STORAGE

2. Fill up the fuel tank and add fuel stabilizer (if available) to prevent the fuel tank from rusting and the fuel from deteriorating.
3. Perform the following steps to protect the cylinders, piston rings, etc. from corrosion.
 - a. Remove the spark plug caps and spark plugs.
 - b. Pour a teaspoonful of engine oil into each spark plug bore.
 - c. Install the spark plug caps onto the spark plugs, and then place the spark plugs on the cylinder head so that the electrodes are grounded. (This will limit sparking during the next step.)
 - d. Turn the engine over several times with the starter. (This will coat the cylinder walls with oil.)
WARNING! To prevent damage or injury from sparking, make sure to ground the spark plug electrodes while turning the engine over.
 - e. Remove the spark plug caps from the spark plugs, and then install the spark plugs and the spark plug caps.
4. Lubricate all control cables and the pivoting points of all levers and pedals as well as of the side-stand/centerstand.
5. Check and, if necessary, correct the tire air pressure, and then lift the motorcycle so that both of its wheels are off the ground. Alternatively, turn the wheels a little every month in order to prevent the tires from becoming degraded in one spot.
6. Cover the muffler outlet with a plastic bag to prevent moisture from entering it.
7. Remove the battery and fully charge it. Store it in a cool, dry place and charge it once a month. Do not store the battery in an excessively cold or warm place [less than 0 °C (30 °F) or more than 30 °C (90 °F)]. For more information on storing the battery, see page 7-28.

[EWA10951]

TIP

Make any necessary repairs before storing the motorcycle.

SPECIFICATIONS

Dimensions:

Overall length:
2175 mm (85.6 in)
Overall width:
765 mm (30.1 in)
Overall height:
1115 mm (43.9 in)
Seat height:
795 mm (31.3 in)
Wheelbase:
1500 mm (59.1 in)
Ground clearance:
125 mm (4.92 in)
Minimum turning radius:
2800 mm (110.2 in)

Weight:

Curb weight:
245 kg (540 lb)

Engine:

Engine type:
Air cooled 4-stroke, DOHC
Cylinder arrangement:
Inline 4-cylinder
Displacement:
1251 cm³
Bore × stroke:
79.0 × 63.8 mm (3.11 × 2.51 in)
Compression ratio:
9.70 :1
Starting system:
Electric starter
Lubrication system:
Wet sump

Engine oil:

Recommended brand:
YAMALUBE
Type:
SAE 10W-30, 10W-40, 10W-50, 15W-40,
20W-40 or 20W-50

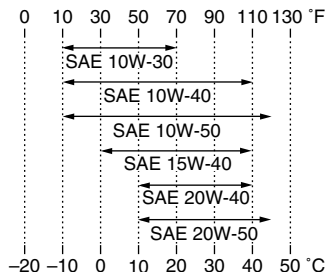

Recommended engine oil grade:
API service SG type or higher, JASO
standard MA
Engine oil quantity:
Without oil filter element replacement:
2.80 L (2.96 US qt, 2.46 Imp. qt)
With oil filter element replacement:
3.15 L (3.33 US qt, 2.77 Imp. qt)

Air filter:

Air filter element:
Oil-coated paper element

Fuel:

Recommended fuel:
Premium unleaded gasoline only
Fuel tank capacity:
21.0 L (5.55 US gal, 4.62 Imp. gal)

Fuel reserve amount:
4.5 L (1.19 US gal, 0.99 Imp. gal)

Fuel injection:

Throttle body:
ID mark:
5UXB 10

Spark plug(s):

Manufacturer/model:
NGK/DPR8EA-9
Spark plug gap:
0.8–0.9 mm (0.031–0.035 in)

Clutch:

Clutch type:
Wet, multiple-disc

Transmission:

Primary reduction ratio:
1.750 (98/56)
Final drive:
Chain
Secondary reduction ratio:
2.235 (38/17)
Transmission type:
Constant mesh 5-speed
Operation:
Left foot operation
Gear ratio:
1st:
2.857 (40/14)
2nd:
2.000 (36/18)
3rd:
1.571 (33/21)
4th:
1.292 (31/24)

5th:
1.115 (29/26)

Chassis:

Frame type:
Double cradle

Caster angle:
25.50 °

Trail:
100 mm (3.9 in)

Front tire:

Type:
Tubeless

Size:
120/70 ZR17M/C (58W)

Manufacturer/model:
DUNLOP/D252F L

Rear tire:

Type:
Tubeless

Size:
180/55 ZR17M/C (73W)

Manufacturer/model:
DUNLOP/D252 L

Loading:

Maximum load:
205 kg (452 lb)
(Total weight of rider, passenger, cargo and accessories)

Tire air pressure (measured on cold tires):

Loading condition:
0–90 kg (0–198 lb)
Front:
250 kPa (2.50 kgf/cm², 36 psi)

Rear:
250 kPa (2.50 kgf/cm², 36 psi)

Loading condition:
90–205 kg (198–452 lb)

Front:
250 kPa (2.50 kgf/cm², 36 psi)

Rear:
290 kPa (2.90 kgf/cm², 42 psi)

High-speed riding:
Front:
250 kPa (2.50 kgf/cm², 36 psi)

Rear:
290 kPa (2.90 kgf/cm², 42 psi)

Front wheel:

Wheel type:
Cast wheel

Rim size:
17M/C x MT3.50

Rear wheel:

Wheel type:
Cast wheel

Rim size:
17M/C x MT5.50

Front brake:

Type:
Dual disc brake

Operation:
Right hand operation

Recommended fluid:
DOT 4

Rear brake:

Type:
Single disc brake

Operation:
Right foot operation

Recommended fluid:
DOT 4

Front suspension:

Type:
Telescopic fork

Spring/shock absorber type:
Coil spring/oil damper

Wheel travel:
130.0 mm (5.12 in)

Rear suspension:

Type:
Swingarm

Spring/shock absorber type:
Coil spring/gas-oil damper

Wheel travel:
110.0 mm (4.33 in)

Electrical system:

Ignition system:
TCI

Charging system:
AC generator

Battery:

Model:
YTZ14S

Voltage, capacity:
12 V, 11.2 Ah

Headlight:

Bulb type:
Halogen bulb

Bulb voltage, wattage × quantity:

Headlight:
12 V, 60 W/55 W × 1

SPECIFICATIONS

Tail/brake light:

LED

Front turn signal light:

12 V, 21.0 W × 2

Rear turn signal light:

12 V, 21.0 W × 2

Auxiliary light:

12 V, 4.0 W × 1

License plate light:

12 V, 5.0 W × 1

Meter lighting:

LED

Neutral indicator light:

12 V, 1.7 W × 1

High beam indicator light:

12 V, 1.7 W × 1

Oil level warning light:

12 V, 1.7 W × 1

Turn signal indicator light:

12 V, 1.7 W × 2

Engine trouble warning light:

12 V, 1.7 W × 1

Immobilizer system indicator light:

LED

Ignition fuse:

15.0 A

Fuel injection system fuse:

15.0 A

Backup fuse:

7.5 A

Fuses:

Main fuse:

50.0 A

Headlight fuse:

15.0 A

Taillight fuse:

7.5 A

Signaling system fuse:

7.5 A

Identification numbers

EAU48611

Record the vehicle identification number and model label information in the spaces provided below for assistance when ordering spare parts from a Yamaha dealer or for reference in case the vehicle is stolen.

VEHICLE IDENTIFICATION
NUMBER:

MODEL LABEL INFORMATION:

Vehicle identification number

EAU26400

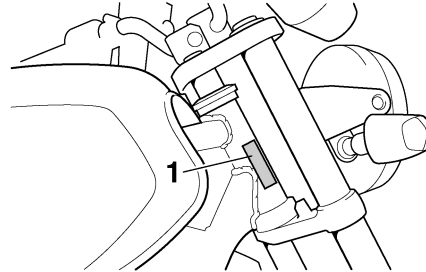

1. Vehicle identification number

The vehicle identification number is stamped into the steering head pipe. Record this number in the space provided.

TIP _____
The vehicle identification number is used to identify your motorcycle and may be used to register your motorcycle with the licensing authority in your area.

Model label

EAU26480

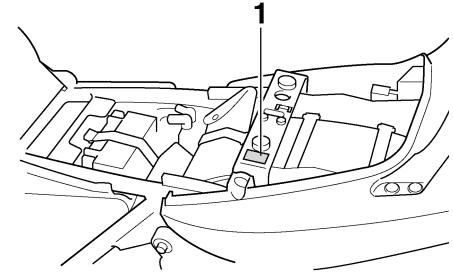

1. Model label

The model label is affixed to the frame under the seat. (See page 4-15.) Record the information on this label in the space provided. This information will be needed when ordering spare parts from a Yamaha dealer.

CONSUMER INFORMATION

EAU26570

Motorcycle noise regulation (for Australia)

TAMPERING WITH NOISE CONTROL SYSTEM PROHIBITED:

Owners are warned that the law may prohibit:

- a. The removal or rendering inoperative by any person other than for purposes of maintenance, repair or replacement, of any device or element of design incorporated into any new vehicle for the purpose of noise control prior to its sale or delivery to the ultimate purchaser or while it is in use; and
- b. The use of the vehicle after such device or element of design has been removed or rendered inoperative by any person.

- A**
- Air filter element and check hose,
 - replacing and cleaning 7-13
 - Auxiliary light bulb, replacing 7-33
- B**
- Battery 7-28
 - Brake and clutch fluid levels,
 - checking 7-20
 - Brake and clutch fluids, changing 7-21
 - Brake and clutch levers,
 - checking and lubricating 7-25
 - Brake and shift pedals,
 - checking and lubricating 7-24
 - Brake lever 4-11
 - Brake lever free play, checking 7-18
 - Brake light switches 7-19
 - Brake pedal 4-12
- C**
- Cables, checking and lubricating 7-24
 - Care 8-1
 - Catalytic converters 4-14
 - Centerstand and sidestand,
 - checking and lubricating 7-26
 - Clutch lever 4-10, 7-18
- D**
- Dimmer switch 4-9
 - Drive chain, cleaning and lubricating 7-23
 - Drive chain slack 7-22
- E**
- Engine break-in 6-3
 - Engine oil and oil filter element 7-10
 - Engine stop switch 4-9
 - Engine trouble warning light 4-4
 - EXUP system 4-21
- F**
- Front and rear brake pads, checking 7-19
 - Front fork, adjusting 4-17
 - Front fork, checking 7-27
 - Fuel 4-13
 - Fuel consumption, tips for reducing 6-3
 - Fuel tank breather/overflow hose 4-14
 - Fuel tank cap 4-12
 - Fuses, replacing 7-29
- H**
- Handlebar switches 4-9
 - Hazard switch 4-10
 - Headlight bulb, replacing 7-30
 - Helmet holder 4-16
 - High beam indicator light 4-4
 - Horn switch 4-9
- I**
- Identification numbers 10-1
 - Ignition circuit cut-off system 4-22
 - Immobilizer system 4-1
 - Immobilizer system indicator light 4-5
 - Indicator lights and warning lights 4-4
- L**
- Labels, location 1-1
 - License plate light bulb, replacing 7-33
 - Luggage strap holders 4-21
- M**
- Main switch/steering lock 4-2
 - Maintenance and lubrication, periodic 7-4
 - Maintenance, emission control system ... 7-3
 - Matte color, caution 8-1
 - Model label 10-1
 - Multi-function display 4-6
- N**
- Neutral indicator light 4-4
 - Noise regulation (for Australia) 10-2
- O**
- Oil level warning light 4-4
- P**
- Panels, removing and installing 7-8
 - Parking 6-4
 - Part locations 3-1
 - Pass switch 4-9
- S**
- Safety information 2-1
 - Seat 4-15
 - Shifting 6-2
 - Shift pedal 4-11
 - Shock absorber assemblies,
 - adjusting 4-18
 - Sidestand 4-22
 - Spark plugs, checking 7-9
 - Specifications 9-1
 - Speedometer 4-5
 - Starting the engine 6-1
 - Start switch 4-9
 - Steering, checking 7-27
 - Storage 8-3
 - Storage compartment 4-16
 - Swingarm pivots, lubricating 7-26
- T**
- Tachometer 4-5
 - Tail/brake light 7-32
 - Throttle grip and cable,
 - checking and lubricating 7-24
 - Throttle grip free play, checking 7-14
 - Tires 7-15

INDEX

Tool kit	7-2
Troubleshooting	7-37
Troubleshooting chart	7-38
Turn signal indicator lights	4-4
Turn signal light bulb, replacing	7-32
Turn signal switch	4-9

V

Valve clearance	7-15
Vehicle identification number	10-1

W

Wheel bearings, checking	7-28
Wheel (front)	7-34
Wheel (rear)	7-35
Wheels	7-17



PRINTED ON RECYCLED PAPER

PRINTED IN JAPAN
2010.09-0.3x1 CR
(E)